

15. J. J. Pluth and J. V. Smith, *J. Am. Chem. Soc.*, **105**, 2621 (1983).
16. S. H. Song, U. S. Kim, Y. Kim, and K. Seff, *J. Phys. Chem.*, **96**, 10937 (1992).
17. "Handbook of Chemistry and Physics", 70th Ed., pF-187 1989/1990.
18. J. F. Charnell, *J. Cryst. Growth*, **8**, 291 (1971).
19. K. Seff, *Acc. Chem. Res.*, **9**, 121-128 (1978).
20. K. Seff and M. D. Mellum, *J. Phys. Chem.*, **88**, 3560 (1984).
21. Principal computer programs used in this study were "Structure Determination Package Programs" written by B. A. Frenzt, and Y. Okaya. These programs were supplied by Enraf-Nonius. The Netherlands (1987).
22. International Tables for X-ray Crystallography, Kynoch, Birmingham, England, Vol. III, 132 (1974).
23. Y. Kim, S. H. Song, J. Y. Park, and U. S. Kim, *Bull. Korean Chem. Soc.*, **9**, 338 (1988).
24. Reference 22, Vol. IV. pp. 73-87.
25. Reference 22, pp. 149-150.
26. A discussion of the zeolite nomenclature is available (a) L. Broussard, D. P. Shoemaker, *J. Am. Chem. Soc.*, **82**, 1041 (1960); (b) R. Y. Yanagida, A. A. Amaro, and K. Seff, *J. Phys. Chem.*, **77**, 805 (1973).
27. "Tables of Interatomic Distances and Configurations in Molecules and Ions" Special Publication No. 11, Chemical Society, Burlington House, London, M-9 (1958).
28. Y. Kim and K. Seff, *J. Phys. Chem.*, **92**, 5293 (1988).
29. Y. Kim and S. H. Song, *J. Korean Chem. Soc.*, **38**, 18 (1989).
30. K. Ogawa, M. Nitta, and K. Aomura, *J. Phys. Chem.*, **82**, 1665 (1978).
31. T. Takaishi and H. Hosoi, *J. Phys. Chem.*, **86**, 2089 (1982).
32. S. H. Song, Y. Kim, and K. Seff, *J. Phys. Chem.*, **95**, 9919 (1991).
33. T. Sun, K. Seff, N. H. Heo, and V. P. Petranovskii, *Science*, **259**, 495 (1993).

Laser Induced Impedance Changes in Hollow Cathode Lamps

Byung Chul Cha, Jae Jung Lee, Ki Beom Lee, Hyo Jin Kim[†],
Gae Ho Lee[‡], and Hasuck Kim*

Department of Chemistry, Seoul National University, Seoul 151-742

[†]*Department of Pharmacy, Dong Duck Women's University, Seoul 136-714*

[‡]*Department of Chemistry, Chungnam National University, Taejon 305-764*

Received April 30, 1993

Laser induced impedance changes in hollow cathode lamps containing sputtered metal atoms have been employed to measure the spectroscopic properties of metal. This technique, known as optogalvanic spectroscopy, has been shown to be a powerful and inexpensive technique for the investigation of atomic and molecular species. Characteristic optogalvanic signals from hollow cathode lamps (HCL) made of different metal species and induced with a pulsed dye laser were observed, and the dependence of the optogalvanic signal on the discharge current and wavelength of laser was measured. Based on the results obtained, the mechanisms involved in evoking the optogalvanic signals were consisted of single-photon absorption, multi-photon absorption, and photoionization. Moreover the current dependence of the optogalvanic signal indicates that the optogalvanic technique could be one of the most sensitive optical methods of detecting atomic species.

Introduction

It is well known that the electric properties of a glow discharge change when it is illuminated with radiation that is resonant to the transitions of atoms contained in the discharge. This perturbation which is called the optogalvanic effect (OGE) is observed as changes in the electric conductivity of the discharge. The main advantage of applying OGE as an analytical tool comes from its simplicity and ease of use. The changes due to OGE can be converted readily into measurable electrical signal, thus, no other complicated optics are required.

The OG effect was first observed by Penning.^{1,2} Others

reported the same effect in different discharges,^{3,4} but the practical application of the OGE began with the introduction of the laser. This effect in relation to the laser was first discovered in a gas discharge laser. When a gas discharge laser was operated, changes were observed in the discharge current as the laser came over the threshold.⁵⁻⁹ The actual development of the OGE as a useful spectroscopic tool started with the work of Green *et al.* who used a tunable dye laser and obtained highly sensitive spectra of the species present in the discharge.¹⁰ They have shown how this technique could be studied with commercial hollow cathode lamps. Zalewski *et al.* also used commercial hollow cathode lamps.¹¹ Wide-ranging applications of the OGE followed, such as the detection of low concentrations or trace element analysis, isotopic analysis of lanthanides, OG spectroscopy with a pulse

*To whom correspondence should be addressed.

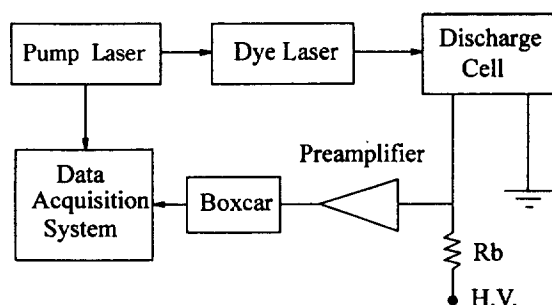

Figure 1. Schematic diagram of the experimental layout for the pulsed optogalvanic spectroscopy. R_b is $5\text{ k}\Omega$ and H. V. is about 400 volts.

laser, and applications to laser calibration and laser stabilization.^{12,13}

It is interesting to find the possibilities of applying the OG spectroscopy to element analysis. As a first step, OG signals with commercial hollow cathode lamps were studied. Previous investigators have noted the following. The best achievable signal with commercial hollow cathode lamps and a c.w. laser was tens of millivolts in the most sensitive cases. However, adopting a pulse laser, the voltage changes across the discharge was tens of volts, which had never been known to other methods involving optical detection.¹²

This study reports the OGE with commercial hollow cathode lamps and several types of pulsed lasers. The characteristic shape of each OG signal with a tuned laser, and the wavelength scan around the absorption maxima of a sputtered metal were studied. We were able to elucidate some part of the whole process responsible for evoking impedance changes in discharges from the dependence of OG signals on discharge current and laser intensity. Analytical aspects of applying the OGE for sensitive detection of metal atoms are also discussed.

Experimental Section

The set-up employed to measure impedance changes is described in Figure 1. Several commercially available hollow cathode lamps (Hamamatsu T.V. Co., Japan) were used as the discharge cell. Every lamp used in this study contained approximately 5 torr of Ne to sustain the discharge. These lamps were operated at constant currents from 3 to 20 mA.

Figure 1 shows the circuit for detecting impedance changes contained a ballast resistor ($5\text{ k}\Omega$) in series with the discharge cell. This resistor maintains the discharge current nearly constant. A wire-wound resistor was used to reduce noise.

Three laser systems were adopted depending on the purpose of the experiment. Commarine 480 (Exciton, OH, USA) dye was used for the shorter wavelength region (460-500 nm) and rhodamine 590 (Exciton) was used for the longer wavelength region (550-580 nm). PDL-2 (Spectra Physics, CA) and PDL-11 (Spectra Physics, CA) Nd: YAG lasers and a Questek model 2440 (Questek, MD) excimer laser with XeCl gas were used as pump lasers. Each laser had distinct characteristics of intensity and pulse width. DCR-2 (Spectra Physics), DCR-3 (Spectra Physics) and FL 3002 (Lambda Physik, Germany) dye lasers were used in combination with these

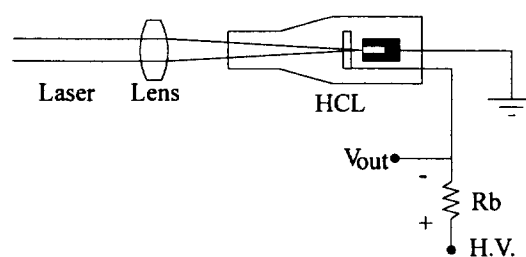

Figure 2. Optical alignment of the experimental apparatus.

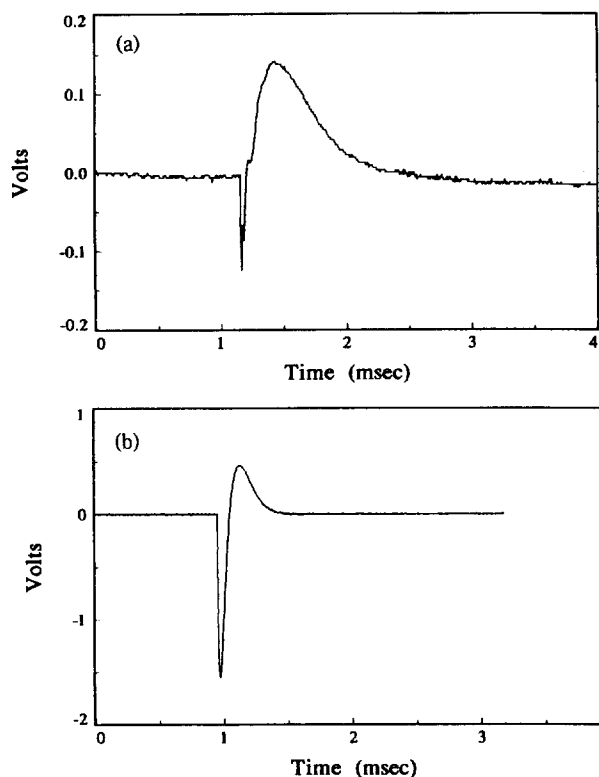

Figure 3. Shape of OG signals from different elements. (a) Ti; 564.414 nm and (b) Ba; 577.700 nm. The discharge current was 5 mA for (a) and 10 mA for (b).

respective pump lasers.

The optical configuration of the measurement is shown in Figure 2. The laser beam is aligned axially to the center of the hollow cathode, and is focused with a convex lens in order to have the focal point located inside the hollow cathode.

The OG signal is monitored and averaged with a Nicolet 4096C (Nicolet, WI) digital oscilloscope. A high pass filter at the input stage is used to eliminate the large d.c. background signal. The RC time constant of the filter is long ($20\ \mu\text{s}$) enough to prevent any significant distortion of the short-lived signals.

A d.c. power supply was built in the laboratory using an MC1466L (Motorola, AZ) regulator and used in a constant current mode.

Results and Discussion

Shapes of OG signals. Figure 3 shows a typical shape

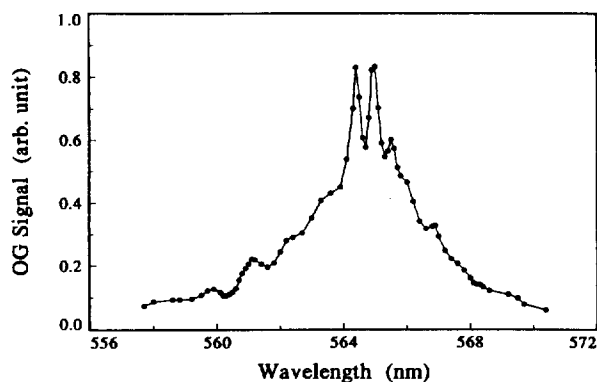

Figure 4. OG spectrum of Ti around 564 nm. The discharge current was 5 mA.

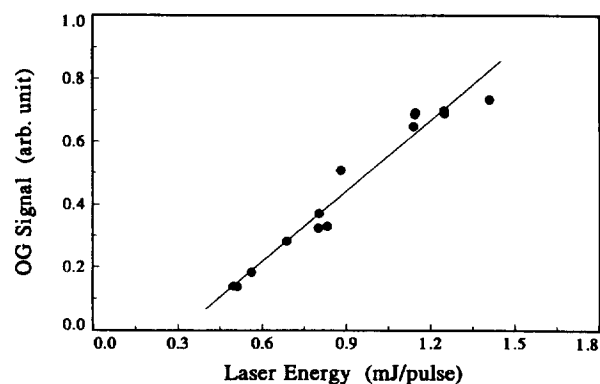

Figure 5. Effect of the pulse energy on the OG signal with titanium. The discharge current was 5 mA.

of the time dependence of OG signal. All the OG signals from different metals had similar patterns consisting of a positive peak after a short negative swing. Those two parts of the signal might be explained as follows. Considering IR drop at the ballast resistor, a negative signal corresponds to an increase in voltage across the resistor caused by an increase in current. The initial negative peak is therefore due to an increase in current caused by sudden increase in electrons produced by the laser pulse. These extra electrons are produced when the laser excited an analyte atom that is just about to collide with a metastable atom. The collision causes the excited atom to ionize. Any extra electrons and ions quickly disappear as they are collected by the electrodes or recombine at the walls of the cell. The negative signal is therefore of short duration. The collision also causes the metastable atom to become a ground state neutral atom thereby reducing the metastable atom population. It takes a relatively long time for the decreased population of metastable atoms to return to its higher equilibrium value. Until the metastable atoms are replenished by electron collisions, the conductance of the plasma decreases because collisions with metastables help to produce the ions and electrons needed to maintain the discharge at its equilibrium current. This decrease in conductance causes the relatively long positive part of the OG signal.

The positive part of the OGE signal in Figure 3(b) is shorter than in Figure 3(a) because the d.c. current for Figure 3(b) is higher than for Figure 3(a). Higher plasma currents produce higher electron collision rates so that the depleted metastable population returns to equilibrium more quickly, causing a shorter positive OGE peak. The positive peak was taken as the OG signal in this work.

The duration of each OG signal is obviously different. This is due to the fact that the signal width depends on the mobility of positive ions involved and the properties of laser pulse such as pulse width, intensity, and the bandwidth of frequency. The pulse widths used in this study were 5 ns (Nd: YAG pumped dye laser) and 25 ns (XeCl excimer laser pumped dye laser). The OG signal of Ti was obtained with excimer laser and that of Ba was measured with Nd: YAG laser. The pulse width certainly effected the shape of the signal. However, it was clear from our results that pulse width influenced little to the height of OG signal

Wavelength Dependence. The wavelength scan near

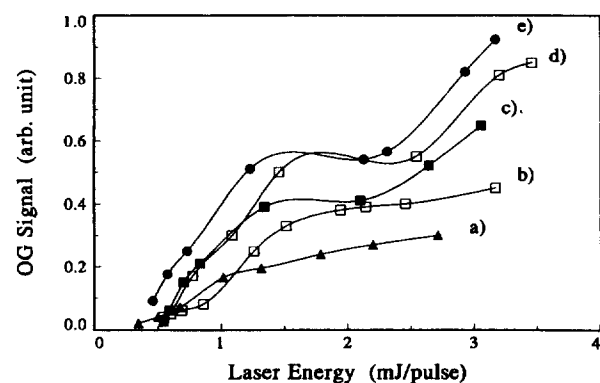

Figure 6. OG signal of Ti vs. pulse energy at different discharge current. (a) 3.8 mA, (b) 6.8 mA, (c) 12.4 mA, (d) 17.2 mA, and (e) 20.1 mA.

the absorption maxima is shown in Figure 4 for a Ti lamp. Three narrow peaks near 564 nm were observed above a broad background, and this point will be discussed in "Powder broadening". The wavelength scan suggested the presence of other transitions of the Ti atom (564.4 nm, 564.8 nm) and of Ne (565.3 nm).

Energy Dependence. Figure 5 illustrates the energy dependence of OG signal of the Ti 564.414-nm transition at a fixed discharge current using the Nd: YAG laser. The discharge current was 5 mA as recommended for routine operation for atomic absorption by the manufacturer. All available levels of pulse energies of the Nd: YAG laser were utilized. Clearly the OG signals depend linearly on the pulse energy. Therefore a single photon transition seems to predominate in evoking the OG effect under these experimental conditions.

Current Dependence. Other OG signals from the 564.414-nm transition of Ti are presented in Figure 6. Those data were obtained over wider range of discharge current from 3.0 to 20 mA and for laser pulse energies up to 3.4 mJ. The trends of the OG signals changes depending upon the ranges of laser pulse energies. The OG signal tends to saturate at lower laser energies when the lamp current is low. This may be caused by the metastable population becoming almost totally depleted by collisions with laser excited atoms during the first part of the OG signal. Higher plasma currents produce more metastables so that saturation (total

depletion) requires higher laser energies as shown in Figure 6. At an extremely high current of 20 mA, a plateau region of signal with increasing the laser energy was observed. The OG signal increased again after the plateau region as the irradiation energy became higher. This is, perhaps, due to photoionization by a second photon. In fact, two processes compete for ionization, *i.e.*, collision induced ionization and photoionization. The collision induced ionization is found to be proportional to the number of collisions, the number of excited atoms, and the states that excited atoms occupy.¹⁴ It is more efficient that the highly excited atoms transfer the internal energy to other atoms than the atoms in lower states. In a high discharge current, the discharge contains a large number of excited neons. The collision number increases according to the discharge current. So the transition by the collision becomes important in higher current value. Consequently, the number of ions generated by the collision induced ionization should be increased. Therefore OG signal is also increasing.

The photoionization is much faster than the collision induced ionization.¹⁴ The excited states of analyte atoms are perturbed by the collision and the atoms are allowed to absorb another photon. Photoionization occurs *via* those processes. So the results exhibits the second increase of OG signal. The collision induced transition also participates in the photoionization. This is why the photoionization is observed only at high current values.

Power Broadening. The frequency bandwidth of the laser output becomes wider as the power increases, which is called laser power broadening. The broadening depends on the first power of laser intensity.^{14,15} Consequently the power broadening causes unintended transitions, which are absorptions by discharge gas and by ions produced in the discharge. Ions ejected from the laser induced ionization can also absorb the broadened irradiation. Furthermore, single-photon or multiphoton processes could induce the transition. Intense transitions of Ne I, and Ne II exist widely in the visible region. Comparing the concentration of Ne to that of the sputtered analyte metal atoms in the discharges, the impedance changes caused by Ne are large enough to disturb the OGE seriously. Moreover, power broadening encourage those types of transitions. As a result, the background OG signal increased as the intensity of the laser increased. So it was necessary to consider the background signal to have more meaningful signals.

Two-Photon Process. A two-photon process has so small of an absorption cross section that the concentration of the absorbent is much more responsible for producing a detectable signal. Generally, a two-photon process occurs easily in species with dense energy levels such as organic molecules and heavy metals, in transitions between highly-excited states, and in an environment where intermolecular vibrational-coupling takes place easily.¹⁶ In other words, the processes are observable at relatively high partial gas pressures. Therefore a two-photon OG signal is largely due to species that have a high concentration in the discharge. Moreover, a two-photon process is predominant with a high intensity pulse laser because the transition probability depends on the second power of laser intensity. Since the hollow cathode lamps used in this investigation were filled with about 5 torr of Ne, the number of collisions is about in the

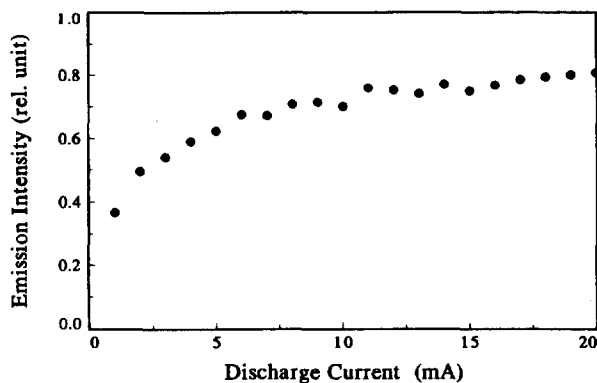

Figure 7. Current dependence of emission intensity of Fe hollow cathode lamp ($\lambda=372.0$ nm).

order of 10^8 per second, which is quite sufficient for intermolecular energy transfer. Therefore the experimental data in Figure 6 must have some contribution from the two-photon process.

Photoelectric effect. The photoelectric effect was unavoidable with the hollow cathode lamps we employed because of their geometric configuration. It is inevitable to cause the direct exposure of the cathode surface to the laser in our optical alignment since the focused beam was placed axially down the center of the hollow cathode. The ejected electrons move toward the anode, collide with the species present in the discharge, and eventually affect the discharge. The impedance change by photoelectrons, therefore, could contribute to the OG signal. The Ne ions also participate in collision-induced ionization in the OGE, but a different mechanism must be followed when the photoelectron is ejected into the plasma. It is very difficult to quantify the effect of photoelectron because the detailed local structure of the cathode surface as well as its physical properties should be considered.

Considering all the troubles that may be induced by photoelectrons, it seems better to make the cathode in a pipe shape and to place it in the middle of lamp tube instead of using commercial ones so that the cathode surface is not directly exposed to laser light.

Analytical Aspects. Figure 7 shows the emission intensity of hollow cathode lamps measured with a photomultiplier tube. The emission intensity at different discharge current implies the presence of self absorption. This is, for example, one of the problems associated with the emission spectroscopy in element analysis. On the contrary, as shown in Figure 5, the OGE data reveals a linear dependency on the certain range of laser power at a given concentration of atoms in the plasma. Since the concentration of sputtered atoms is dependent on the discharge power and the OG signal reflects only the electrical variations in the discharge, the OG effect must not be affected by self absorption which weakens the emission intensity and perturbs the linearity between the concentration and the net analyte signal. Very sensitive signals is obtained with such a simple electronic device for OG spectroscopy, which are responsible for the presence of electrons and ions produced by light energy from neutral atom. Lock-in amplifier or 2-channel box car integrator measurements could be employed with chopped dye laser

for the OGE measurement to get even better quality signals.¹⁷

Conclusions

We have studied laser induced impedance changes obtained with a Ti hollow cathode lamps. We were able to acquire big OG signals from Ti lines with high intensity pulsed lasers. In addition to narrow peaks, the spectral profile showed a broad background and additional lines that may have been caused by such things as two-photon transitions by discharge gas and atoms, a photoelectric effect from the cathode surface, photoionization, a wide spectral laser bandwidth, and laser power broadening of the atomic transitions. The development of optogalvanic spectroscopy as a potential analytical technique requires that these problems be solved.

Acknowledgment. Financial supports by the Ministry of Education of the Republic of Korea through the Basic Science Research Program (1992) and by the Seoul National University-Daewoo Foundation Program (1993) were greatly appreciated. Authors are grateful to Prof. E. H. Piepmeier at Oregon State University, U.S.A. for valuable comments and suggestions made on the manuscripts and to the Inter-university Center for Natural Science Research Facilities at Seoul National University (Nd: YAG laser) and the Instrumental Analysis Laboratory at the Korea Institute of Geology, Mining and Materials in Taejeon (excimer laser) for letting us to use their laser facilities.

References

1. F. M. Penning, *Physica*, **8**, 137 (1928).
2. F. M. Penning, "Electrical Discharges in Gases", Philips Technical Library, 1957.
3. C. Kenty, *Phys. Rev.*, **80**, 95 (1950).
4. K. W. Meissner and W. F. Miller, *Phys. Rev.*, **92**, 896 (1953).
5. A. Garscadden, P. Bletzinger, and E. M. Friar, *J. Appl. Phys.*, **35** 3432 (1964).
6. G. Schiffner and F. Seifert, *Proc. IEEE*, **53**, 1657 (1965).
7. A. Garscadden and S. L. Adams, *Proc. IEEE*, **54**, 427 (1966).
8. R. F. Freiberg and L. A. Weaver, *J. Appl. Phys.*, **38**, 250 (1967).
9. A. J. Carswell and I. I. Wood, *J. Appl. Phys.*, **38**, 3828 (1967).
10. R. B. Green, R. A. Keller, P. K. Schenk, J. C. Travis, and G. G. Luther, *J. Am. Chem. Soc.*, **98**, 8517 (1976).
11. R. A. Keller, R. Engleman, Jr., and E. F. Zalewski, *J. Opt. Soc. Am.*, **69**, 738 (1979).
12. G. J. Benen, B. P. Lessard, and E. H. Piepmeier, *Anal. Chem.*, **51**, 1721 (1979).
13. B. Barbieri and N. Beverini, *Rev. Mod. Phys.*, **62** 603 (1990).
14. V. S. Letokhov, "Laser Photoionization Spectroscopy", Academic Press, New York, 1987.
15. E. H. Piepmeier, "Analytical Applications of Lasers", John Wiley & Sons, New York, 1986.
16. R. D. Levine and R. B. Bernstein, "Molecular Reaction Dynamics and Chemical Reactivity", Oxford University Press, Oxford, 1985.
17. P. Camus, *J. de Physique*, **44**, C7-87 (1983).

Photo-Crosslinking of Poly (glycidyl methacrylate) Initiated by N-Hydroxyphthalimide Sulfonates

Kyu Ho Chae*, Ik Ju Park, and Min Ho Choi

Department of Polymer Engineering, Chonnam National University, Kwangju 500-757

Received May 6, 1993

The photoacid generation efficiency of four N-hydroxyphthalimide sulfonate derivatives was studied by photo-crosslinking reaction of poly (glycidyl methacrylate) in solid film state. The relative photoacid generation efficiency was increased in the order of N-hydroxyphthalimide methanesulfonate > -toluenesulfonate > -nitrobenzenesulfonate > -dinitrobenzenesulfonate, and the reaction was efficiently sensitized by benzophenone suggesting that this photoreactions is likely to proceed through its triplet excited state.

Introduction

Photoinitiators play an essential role in the light induced polymerization process. They are widely used for photocurable coatings, UV inks, paints, printing plates, and adhesives.¹ Photoinitiators can be classified into two types on the basis of the reaction mechanisms *i.e.*, free radical and cationic photoinitiators. Most of the technically applied photochemical

processes are based on free radical photoreactions at present. The cationic photoinitiators, however, have several advantages over radical photoinitiators such as no oxygen inhibition, induction of ring opening polymerization, and no volume contraction during polymerization and it appears that in addition to free radical also cationic photoinitiators will be increasingly applied in the future.²⁻⁵

Crivello *et al.*,⁶⁻⁹ have discovered that onium salts are effi-