

28. Jiang, M.; Zhou, X.; Zhao, Z. *J. Electroanal. Chem.* **1990**, *287*, 389.
29. Leidner, C. R.; Murray, R. W. *J. Am. Chem. Soc.* **1984**, *106*, 1606.
30. Feldman, B. J.; Melroy, O. R. *J. Electroanal. Chem.* **1987**, *234*, 213.
31. Orata, D.; Buttry, D. A. *J. Am. Chem. Soc.* **1987**, *109*, 3574.
32. Deakin, M. R.; Byrd, H. *Anal. Chem.* **1989**, *61*, 290.
33. Prater, K. B.; Adams, R. N. *Anal. Chem.* **1966**, *38*, 153.
34. Galus, Z.; Adams, R. N. *J. Phys. Chem.* **1963**, *67*, 86.
35. Kawiak, J.; Jedral, T.; Galus, Z. *J. Electroanal. Chem.* **1983**, *145*, 163.
36. Oyama, N.; Ohsaka, T.; Yamamoto, N.; Matsui, J.; Hatozaki, O. *J. Electroanal. Chem.* **1989**, *265*, 297.
37. Nakamoto, K. *Infrared Spectra of Inorganic and Coordination Compounds*; John Wiley & Sons: New York, 4th Ed.

Determination of Trace Metals in Atmospheric Particulates by Ion Chromatography

Yong-Keun Lee*, Hak-Chul Kim†, and Dong Soo Lee

Department of Chemistry, Yonsei University, Seoul 120-749, Korea

Received June 15, 1994

A simple and fast ion chromatographic method is developed for the determination of transition metals such as Fe, Cu, Ni, Zn and Co in atmospheric particulates. The method involves acid digestion, on-column preconcentration, and subsequent ion chromatographic detection. The precision of the method is less than 3% RSD at parts per billion level for the metals studied. No significant interferences are observed. The results obtained with this method agree well with those by ICP-AES.

Introduction

Transition metals such as Fe, Cu, Ni, Zn and Co in atmospheric particulates have been determined because of their environmental toxicities toward human health.¹⁻³ Various methods⁴⁻⁷ have thus far been used and each method has its own merits and weaknesses. In this paper, an IC Method was used for the first time.

Since late 1970s, many researchers have been actively involved in the simultaneous determination of transition metals by ion chromatography. Transition metal ions are particularly suited for spectrometric detection using post column reaction with reagents such as 4-(2-pyridylazo)resorcinol (PAR), arsenazo III or dithizone.⁸⁻⁹ Alternatively, transition metal ions may be detected by electrochemical methods such as coulometry at controlled potential, conductivity measurement and amperometry using various designs of working mercury electrodes.¹⁰⁻¹³ However, there have been few reports of applying ion chromatography for the determination of transition metals in real environmental samples. Recently, ion chromatography has been applied for the determination of Fe, Cu and Zn in rainwater.¹⁴

In this study, we applied ion chromatography to the determination of Fe, Cu, Ni, Zn and Co in atmospheric particulates. By employing on-column preconcentration we have lowered detection limit significantly and removed matrix interferences.

Experimental

Reagent and Apparatus. A Dionex 4000i ion chromatograph equipped with Dionex HPIC-CG5 concentration column (4×50 mm), HPIC-CS5 analytical column (4×250 mm) and 0.5 ml sample loop was used in this study. Most experiments were performed with an eluent of 6 mM pyridine-2,6-dicarboxylic acid (PDCA, Tokyo Kasei) at a pump rate of 1.0 ml/min. Eluent pH was adjusted to 4.6 with sodium acetate and acetic acid. A JAI model UV-detector 3702AB and a Hitachi model chromatointegrator D-2000 were used for data collection.

Atmospheric particulates were collected using a Kimoto model HV-121FT high volume air sampler. Labtam model UV-20, inductively coupled plasma atomic emission spectrometer was used for elemental analysis.

All solutions in this work were prepared with deionized water from Milli-Q system (Millipore Co.). HNO₃ and HF used for acid digestion were redistilled in Teflon still. 0.0125% 4-(2-pyridylazo)resorcinol (PAR) solution (Dotite) was prepared with 3 M NH₄OH and 1 M acetic acid. All other reagents were of reagent grade.

Multielement standard solutions were prepared by successive dilution of commercial 1,000 µg/ml atomic absorption standards (J. T. Baker). Certified reference materials (SRM) for urban particulate matters (NIST SRM-1648, U. S. A.) and vehicle exhaust particulate (NIES SRM-8, Japan) were analyzed for evaluating accuracy.

Particulate Collection and Dissolution. Atmospheric particulates were collected using a high volume sampler

*Present Address, Doosan Technical Center, 39-3, Songbok-Ri, Suji-Myon, Yongin-Gun, Kyonggi-Do 449-840, Korea

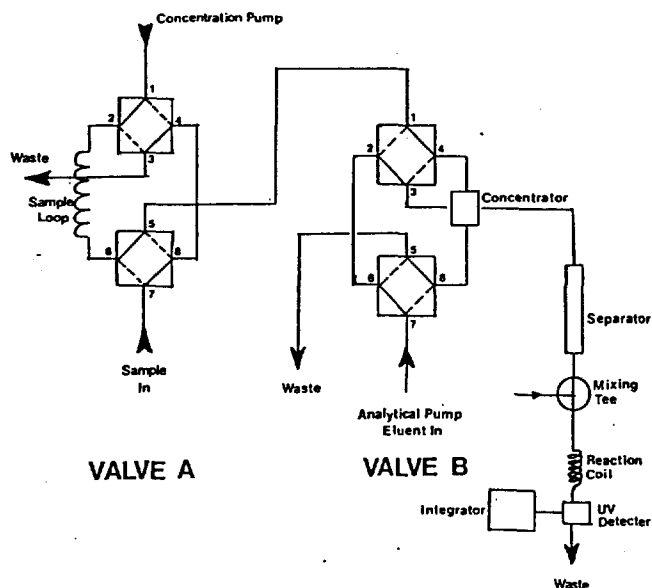

Figure 1. Schematic diagram of ion chromatograph used in this study.

at Shinchon campus of Yonsei University, Seoul, Korea. The sampler was installed on the roof of the Science building. Air was withdrawn through a Whatman No. 41 cellulose filter paper (20.3×25.3 cm) at a flow rate of approximately 750 l/min for a period of 12 or 24 hrs. Aerosol laden filters were cut into 4×4 cm rectangular form using ceramic scissors so that sample contamination was minimized. A filter cut was acid digested with 3 ml of hyperchloric acid and 3 ml of nitric acid in 50 ml Teflon beaker at 160 °C for 3 hrs with watch glass covered. Resulting clear yellow solution was evaporated to dryness on a hot plate. To dissolve silicate minerals, 1 ml HF, was added and heated to dryness. The residue was dissolved with a small amount of 0.03% H₂O₂, transferred to 25 ml volumetric flask, and messed up to the mark with distilled water.

Ion Chromatographic analysis. The sample solution was concentrated by an on-column pre-concentration method. The operational principle and schematic diagram are shown in Figure 1.

As shown in Figure 1, pre-concentration is proceeded as follows: when solution path in valve A is going through the dotted line in Figure 1, sample solution is injected through injection port 7 and 0.5 ml sample loop is filled with sample solution. As solution path in valve A is changed to dashed line, sample solution passes through 1→2→6→5 in valve A, then 1→4→8→5→ in valve B. In this stage, only metal ions are concentrated in a concentration column in valve B.

The solution path in valve B is changed to a dotted line after sample solution is concentrated for 150 sec, in order to allow the eluent to pass through 7→8→4→3 in valve B. Here, concentrated metal ions are redissolved in the eluent to be introduced in separator column.

Result and Discussion

Optimum condition for on-column pre-concentra-

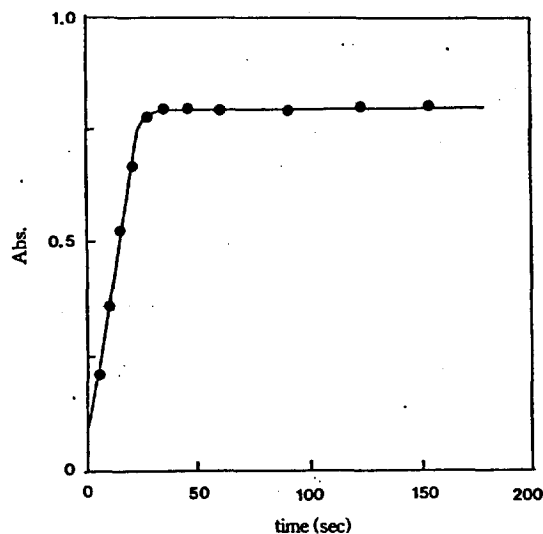

Figure 2. Effect of pumping time on on-column pre-concentration.

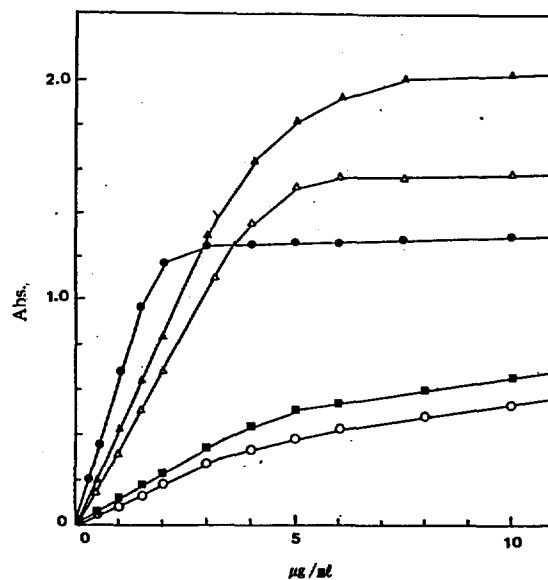

Figure 3. Maximum adsorption of each metal on concentrator column. ○; Fe(II), △; Cu(II), ▲; Ni(II), ■; Zn(II), ●; Co(II).

tion. One major advantage of using on-column pre-concentration technique is to improve sensitivity, which stems from large sample injection volume and from minimum peak broadening. An additional advantage can be realized in terms of both simplicity and speed if sample concentration can be achieved by changing path of elution process.

The purpose of the first experiment was to find time needed for reaching maximum capacity of concentrator column. In present work, flow rate for concentration pump was fixed at 1.4 ml/min when acid digested sample was concentrated on concentrator column. In those condition, the operation time of concentration pump to flow 1 ppm Fe(III) standard solution was varied and the time to reach maximum read out in recorder was checked. Figure 2 shows 30 sec of concentration time after initial injection is enough to reach maximum absorbance (peak height). However, in present work,

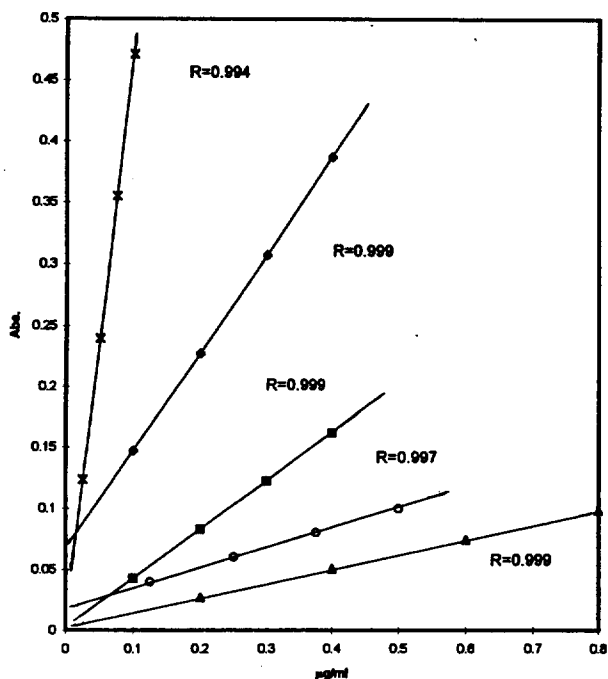

Figure 4. Calibration curves for metals obtained by the present method. \diamond ; Fe(II), \blacksquare ; Cu(II), \blacktriangle ; Ni(II), \circ ; Zn(II), $*$; Co(II).

Table 1. Maximum Adsorption Capacity and Linear Dynamic Range of the Concentrator Column for Each Metal

Metal ion	Amt. of Maximum Adsorption ($\times 10^{-5}$ mmole)	Linear Range ($\mu\text{g/ml}$)
Fe(III)	1.3	0-1.5
Cu(II)	2.5	0-3.2
Ni(II)	3.1	0-3.6
Zn(II)	2.5	0-3.3
Co(II)	2.9	0-3.4

extra time was needed to neutralize strong acidic sample solution. The continuous work of concentration pump for 150 sec made the sample solution neutralized, which was checked by litmus paper. Even in more than 150 sec in concentration time, metal ions adsorbed on concentrator column wasn't affected.

The maximum capacity of concentrator column for each metals applied was checked as measuring peak height derived by continuous injecting standard solution of each metal ions from low concentration to high concentration. From Figure 3, the concentrations deviated from linearity maximum adsorption quantity for each metal ions were calculated. The calibration curves (Figure 4) for each metals were obtained with standard solution, and from those curves linear dynamic ranges for each metals were found. Both data were listed in Table 1.

Elution behavior and resolution as a function of eluent pH. In this work, 6 mM Pyridine 2,6-Dicarboxylic Acid (PDCA) solution was chosen for metal elution. In order to find optimal separation condition, metal ion retention characteristics were examined at various pH. Eluent pH

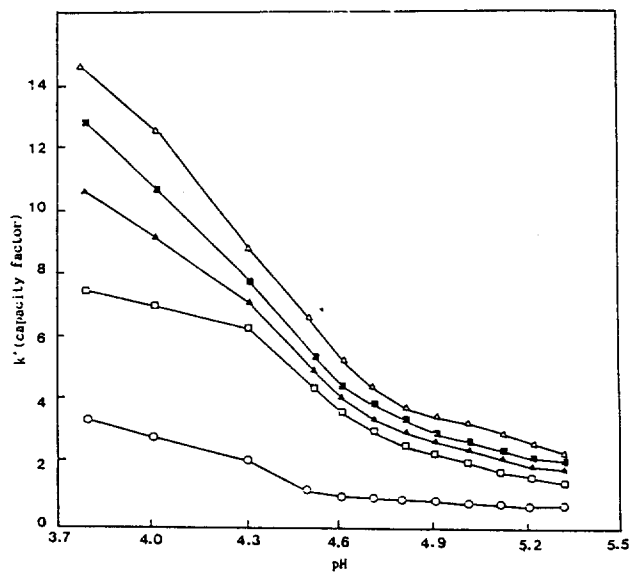

Figure 5. Variation of capacity factor as a function of the eluent pH. \circ ; Fe(III), \square ; Cu(II), \blacktriangle ; Ni(II), \blacksquare ; Zn(II), \triangle ; Co(II).

Table 2. Resolution as a Function of Eluent pH

pH	Fe-Cu	Cu-Ni	Ni-Zn	Zn-Co
4.3	5.71	1.08	0.71	1.33
4.5	6.48	1.12	0.81	1.28
4.6	6.06	1.27	0.78	1.33
4.7	4.32	1.07	0.75	1.27
4.8	3.52	1.16	0.77	1.21
4.9	3.86	1.10	0.78	1.05
5.0	2.58	1.15	0.81	1.02

$$R_s = 2(t_2 - t_1) / (t_{w2} + t_{w1})$$

was adjusted with sodium acetate/acetic acid buffer. Figure 5 shows each metal capacity factor, k' which is defined by $(t_r - t_o) / t_o$. Herein, t_r and t_o represent retention times for metal ion of interest and for water dip, respectively. As eluent pH increases, k' values for all metal ions decrease rapid at lower pH and then slowly at pH above 4.6. The observed elution behaviors are explainable on the basis of PDCA dissociation. At higher pH most PDCA exists in ionized forms and thus metal elution becomes more efficient than at lower pH. It is not possible to predict elution behaviors accurately since PDCA dissociation constant is not available. However it may not differ much from those of pyridine mono carboxylic acids being in the order of 10^{-5} and this is in good agreement with the experimental observations. The metal elution order, Fe(III), Cu(II), Ni(II), Zn(II) and Co(II) is also explainable on the basis of complex stability. Trivalent ferric ion forms the most stable complex with PDCA. For the remaining divalent ions, the order follows William-Irving series except Zn(II) and Co(II). The reason for the reverse order is not clear. Perhaps impurity ions like halides might play some role.

Another factor to consider separation optimization is peak separation. In Table 2 are listed resolution, R_s being defined in the following equation:

Table 3. Absorption Maxima of Metal-PAR Complexes

Metal-PAR Complex	λ_{max} (nm)	ϵ ($\text{cm}^{-1}\text{mole}^{-1}\text{liter}$)
Fe(III)	500	2.54×10^4
Cu(II)	510	3.97×10^4
Ni(II)	495	7.01×10^4
Zn(II)	495	3.58×10^4
Co(II)	515	5.72×10^4

ϵ ; molar absorptivity.

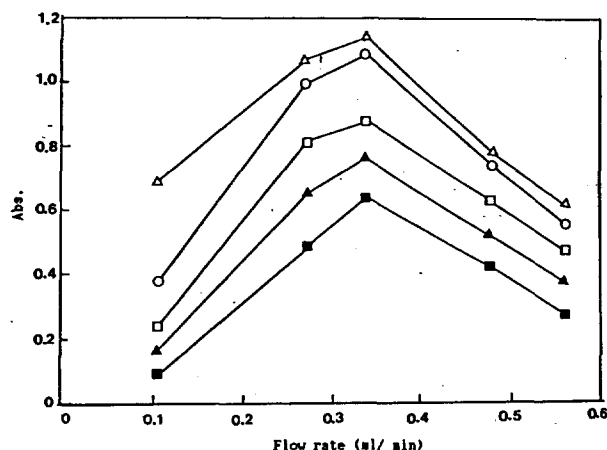

Figure 6. Variation of absorbance as a function of the flow rate of PAH solution. ○; Fe(III), □; Cu(II), ▲; Ni(II), ■; Zn(II), △; Co(II).

$$R_s = 2(t_2 - t_1) / (t_{w2} + t_{w1})$$

In the equation t_1 and t_2 are the retention times for two adjacent peaks and t_{w1} and t_{w2} are peak widths. As pH changes, the resolution varies little except for Fe(III)-Cu(II) couple. Rather large variations for Fe(III) and Cu(II) are probably due to a large difference in stability constants which stems from large charge difference, trivalent and divalent. Therefore in the following experiment, we have chosen pH of 4.6 which gave the best peak resolutions.

Post column reaction with PAR. For the detection of heavy metals a common used method, UV detection after post-column reaction was employed in this study. As coloring agent 4-(2-pyridylazo) resorcinol (PAR) was used. For general application one would select the detection wavelength with the best sensitivity for all the metals. However, aerosol analysis is in different situation since the metal concentrations vary greatly. In this case one should select the wavelength with the maximum absorbance for least abundant element, so that best peak resolutions and simultaneous multi-element analysis could be achieved. In Table 3 are listed the wavelengths of maximum absorption (λ_{max}) and molar absorptivity (ϵ) for metal-PAR chelates. In this experiment we have chosen 510 nm which is close to the maximum absorption wavelength for the least abundant metals, Ni, Co, Cu in the atmospheric particulates.

For the purpose of mixing eluent with PAR solution a mixing tee was used. Initially we have tested a commercial

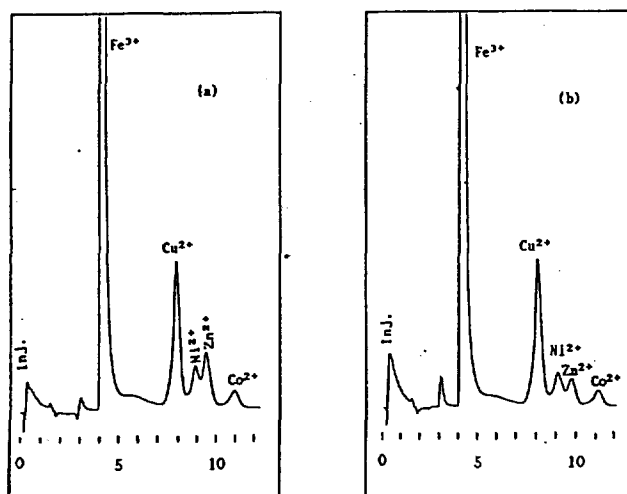

Figure 7. Ion Chromatograms for standard and real sample. (a) standard: Fe(III) 3 ppm, Cu(II) 0.8 ppm, Ni(II) 0.2 ppm, Zn(II) 0.3 ppm, Co(II) 0.06 ppm. (b) urban atmospheric particulate sample (89. 8. 29). Condition: same as in Table 2.

Table 4. Sensitivity and Limit of Detection

Metal ion	Sensitivity (abs/ $\mu\text{g}/\text{ml}$)	Limit of Detection ($\mu\text{g}/\text{ml}$)
Fe(III)	1.03	1.2×10^{-3}
Cu(II)	0.420	3.0×10^{-3}
Ni(II)	0.125	5.2×10^{-3}
Zn(II)	0.096	1.3×10^{-2}
Co(II)	0.480	4.5×10^{-3}

postcolumn membrane reactor, but the sensitivities were not better than using a mixing tee. We observed more pronounced peak broadening when the membrane reactor was used. The optimum sensitivity was sought by measuring absorbance of metal ion peaks at various flow rate of PAR solution. As shown in Figure 6, the maximum absorbances were observed at a flow rate of 0.35 ml/min for all metals and thus this flow was used in the subsequent experiments.

Control of oxidation state and effect of matrix. In principle oxidation state differentiation is possible with this method. However, in practice we have not investigated this possibility because it is very likely that oxidation state interconversion might occur in acid digestion process. However, it is desirable to keep one metal in one form, otherwise every species concentrations must be determined in order to get total concentration.

Among the five metals studied in this work, only iron reveals two oxidation states, ferrous and ferric. Among two routes, reduction to ferrous or oxidation to ferric, we have chosen the latter for two reasons. Firstly it is simple, easy and interference-free to make oxidation which can be done by adding small amounts of hydrogen peroxide. Secondly ferric ion eluates first without overlapping other ion peaks making analysis time short. On the other hand, ferrous ion eluates last. Simple addition of H_2O_2 to make 0.03% concentration at room temperature converts all iron into ferric insta-

ntaneously.

Despite very complex matrix of atmospheric particulate digest, no measurable matrix interferences were experienced. Typical chromatograms for sample and standard solution are shown in Figure 7. There were no observable differences between the two. It is believed that most matrix components are removed during on column preconcentration.

Sensitivities and Limits of Detection. The figures for sensitivities and limits of detection (LOD) of this method are listed in Table 4. The sensitivities are defined by the slopes of the calibration curves and LOD by three times standard deviations of baseline noise.

Precision and Accuracy. The precisions of the ion chromatographic measurement by repeated analysis of synthetic mixed standards were in the order of 2-3%.

The accuracy were evaluated by analyzing two certified reference materials. In Table 5 are the results for certified

Table 5. Analytical Results for SRMs Obtained by the Present Method and Their Certified Value

Element	NIST ^a		NIES ^b	
	A	B	A	B
Fe	39100±1100	39500±1400	4850±500**	4577±162
Cu	609±27	571±21	67.0±1.1	59.4±3.2
Ni	82±3	—	18.7±0.9	—
Zn	4760±140	4590±96	1010±40	965.0±30
Co	18	10±0.5	4.3±0.4	6.0±0.2

A; certified values, **may not be homogenous. B; The results obtained by the present method. Conc unit; µg/g, n (injection time)=5. a; National Institute of Standard and Technology (previous NBS). 1648; Urban Particulate Matter. b; National Institute for Environmental Studies, Japan. No. 8; Vehicle Exhausted Particulates. —; can not be measured

Table 6. Analytical Results for Seoul Atmospheric Particulates Obtained by the Present Method and by ICP-AES

Metal	Sample 1			Sample 2			Sample 3		
	IC	ICP	IC/ICP	IC	ICP	IC/ICP	IC	ICP	IC/ICP
Fe	6.12	6.14	1.00	13.5	13.2	1.02	3.18	3.14	1.01
Cu	0.32	0.39	0.82	0.41	0.46	0.89	0.79	0.82	0.96
Ni	0.26	0.28	0.93	0.65	0.70	0.93	0.21	0.29	0.72
Zn	1.42	1.49	0.95	1.00	0.93	1.08	0.30	0.33	0.91
Co	0.026	ND	ND	0.065	ND	ND	0.063	ND	ND

Conc unit; µg/ml. Sample 1, 2, 3, are collected on July 26, Aug. 7 and Aug. 28, 1989, respectively. ND; not determined

reference materials for urban atmospheric particulate of the National Institute of Standard and Technology of USA and vehicle exhausted particulates of National Institute for Environmental Studies of Japan showing fair agreements with certified or recommended values. For both standards nickel could not be determined due to the overlap of extremely high zinc peak. By this method three atmospheric particulate samples collected in Seoul were analyzed. The same samples were also analyzed by inductively coupled plasma atomic emission spectrometry. Both results are summarized in Table 6. There are good agreements between two methods including nickel data.

Acknowledgment. The present study was supported by the Basic Science Research Institute Program (No. BSRI-93-331), Ministry of Education, 1993.

References

- Hirosch, Y.; Peleg, M.; Luria, M. *Environ. Sci. Technol.* **1981**, *15*, 1456.
- Pimenta, J. A.; Wood, G. R. *Environ. Sci. Technol.* **1980**,

- 14, 556.
- Ramdahl, T.; Becher, G.; Bjørseth, A. *Environ. Sci. Technol.* **1982**, *16*, 861.
- Burnhan, C. D.; Moore, C. E.; Kanabrocki, E. *Environ. Sci. Technol.* **1969**, *3*, 472.
- Sugimae, A.; Hasegawa, T. *Japan Analyst* **1973**, *22*, 3.
- Iwatsuki, M.; Tillekratne, S. P.; Fukasawa, T. *Environ. Sci. Technol.* **1984**, *18*, 818.
- Eilis, K. M.; Chattopadhyay, A. *Anal. Chem.* **1979**, *51*, 942.
- Elchuk, S.; Cassidy, J. M. *Anal. Chem.* **1979**, *51*, 1434.
- Schmidt, G. J.; Scott, R. P. W. *Analyst.* **1984**, *109*, 997.
- Nordmeyer, F. R.; Hamsen, L. D.; Eatough, D. J.; Rollins, D. K.; Lamb, J. D. *Anal. Chem.* **1980**, *52*, 852
- Lams, J. D.; Hansen, L. D.; Patch, G. G.; Nordmeyer, F. R. *Anal. Chem.* **1981**, *53*, 749
- Cassidy, R. M.; Elchak, S. *Anal. Chem.* **1982**, *54*, 1558
- Sevench, G. J.; Fritz, J. S. *Anal. Chem.* **1983**, *55*, 12.
- Lee, Y. K.; Lee, K. H.; Lee, D. S. *J. Kor. Air Pollut. Res. Assoc.* **1991**, *7*, 137.