

- 5173.
41. Cole, S. J.; Bartlett, R. J. *J. Chem. Phys.* **1987**, *86*, 873.
42. Lathan, W. A.; Hehre, W. J.; Curtiss, L. A.; Pople, J. A. *J. Am. Chem. Soc.* **1971**, *93*, 6377.
43. Pople, J. A.; Luke, B. T.; Frisch, M. J.; Binkley, J. S. *J. Phys. Chem.* **1985**, *89*, 2198.
44. Herzberg, G.; Ramsey, D. A. *J. Chem. Phys.* **1952**, *20*, 347; Herzberg, G.; Ramsey, D. A. *Discuss. Faraday Soc.* **1953**, *14*, 11.
45. Herzberg, G. *Electronic Spectra of Polyatomic Molecules*, Van Nostrand, Princeton, 1967.
46. Dressler, K.; Ramsey, D. A. *J. Chem. Phys.* **1957**, *27*, 971.
47. Jungen, Ch.; Hallin, K.-E. J.; Merer, A. *J. Mol. Phys.* **1980**, *40*, 25.
48. Brown, R. D.; Williams, G. R. *Mol. Phys.* **1973**, *25*, 673.

PM3 Studies on the Acid-Catalyzed Hydrolysis of 1-Phenoxyethyl Propionate

Chan Kyung Kim*, In Young Lee, Dong Soo Chung, Bon-Su Lee, and Ikchoon Lee

Department of Chemistry, Inha University Incheon 402-751, Korea

Received June 26, 1998

Acid catalyzed hydrolysis of 1-phenoxyethyl propionate, **I**, has been studied using the PM3 method in the gas phase. The first step of the reaction is the protonation of basic sites, three different oxygens in **I**, producing three protonated species **II**, **III** and **IV**. All possible reaction pathways have been studied from each protonated structure. Changes in the reaction mechanisms have also been discussed from the results obtained by varying a nucleophile from a water monomer to a water dimer to a complex between one water molecule and an intermediate product (propionic acid or phenol) produced in the preceding unimolecular dissociation processes. Minimum energy reaction pathway is 2-W among the possible pathways, in which water dimer acts as an active catalyst and therefore facilitates the formation of a six-membered cyclic transition state. Lower barrier of 2-W is ascribed to an efficient bifunctional catalytic effect of water molecules. PM3-SM3.1 single point calculations have been done at the gas-phase optimized structure (SM3.1/PM3//PM3) to compare theoretical results to those of experimental work.

Introduction

Alkanoates have two special functional groups, ester and acetal, and the hydrolysis of the alkanoates has been studied extensively due to the mechanistic importance of this compound as an intermediate of the enzymic reactions.¹ Mechanistic studies on the hydrolysis of alkanoates have been done experimentally under the acidic, basic, and neutral conditions.² Especially, hydrolysis reactions of ester functional group in acidic or basic condition are known to be fast and these are classified into 8 different reaction mechanisms.³ Under the acidic condition, the reaction is classified into two different modes - acyl and alkyl bond cleavages. The reactions are classified as A_{AC}1 or A_{AC}2 in the former case, and as A_{AL}1 or A_{AL}2 in the latter case depending on the number of molecule involved in the rate determining steps.

R. A. McClelland reported that the unimolecular mechanism is favorable in the case of acyclic system from the studies on the hydrolysis of cyclic and acyclic systems.⁴ R. A. Cox and K. Yates proposed an A-1 mechanism from the ρ values obtained by varying the concentration of acid under the dilute acid.⁵

Recently C. D. Hall and C. W. Goulding carried out an

experimental study on the acid-catalyzed hydrolysis of 1-aryloxyethyl alkanoates (see eq. 1).⁶ Products of the reaction are a carboxylic acid, an aldehyde and an alcohol.

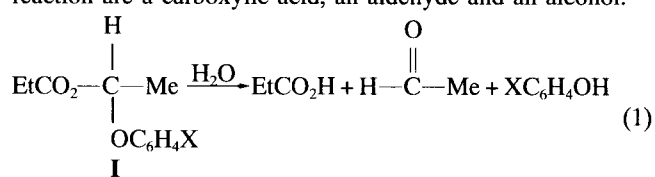

In their study, reaction mechanism was interpreted from the rate constants obtained under strong acidic (low pH) and strong basic (high pH) conditions and substituent effects of aryl ring and ¹⁸O labelling experiments.⁷ The reactions are proposed to proceed through different mechanisms depending on the pH of the reaction medium. In acidic region, the reaction proceeds through an A-1 mechanism (A_{AL}-1) involving predissociation of a carbonium ion and subsequent attack by water. In basic condition, the mechanism is B_{AC}2 and in the neutral region, the reaction is A_{AC}2 mechanism which involves a nucleophilic attack of water molecule to the carbonyl group.⁸⁻¹⁵

In this study, computational method was used to interpret the complex mechanism of 1-phenoxyethyl alkanoate, **I**. In basic media, a tetrahedral intermediate can be easily formed by the addition of hydroxide ion to the carbonyl group without reaction barrier, and this mechanism has been

*Author to whom correspondence should be addressed.

proved in many cases.¹⁶ On the other hand, a zwitterion⁵ will result from the neutral hydrolysis of alkanooate, but the intermediate is not stable in the gas phase due to the charge separation. We, therefore, only considered an acid-catalyzed hydrolysis mechanism of **I** in this study.

Calculations

Semi-empirical method has been used in this study due to the size of the reaction system and the complexity of the reaction mechanisms. PM3 method¹⁷ was selected in order to consider a hydrogen bond between reacting species properly. Mopac package (version 6.0)¹⁸ implemented on the IBM RISC 6000 workstation has been used throughout the calculations.

Reactants, intermediates and products were optimized using the energy gradient method.¹⁹ In order to find a transition state (TS), several structures have been calculated by fixing an important geometrical parameter as a reaction coordinate and a transition state was located using the TS option starting from the highest energy structure.²⁰ All stationary points were verified by the force calculations: all positive frequencies and one imaginary frequency for the ground state and TS, respectively.

Since **I** has three basic oxygen atoms, three protonated structures were considered in the calculations: **II** (protonated on carbonyl oxygen), **III** (protonated on ether oxygen) and **IV** (protonated on phenolic oxygen). All possible reaction pathways were calculated from each protonated structure. The reactions could be classified into three mechanisms depending on the species involved in a nucleophilic step - a water monomer (mechanism 1) shown in Scheme 1, a water dimer (mechanism 2), and a complex between a water and an intermediate product formed from the dissociation of protonated species (mechanism 3). Additional molecule(one water, labelled W or intermediate product, labelled P) was introduced in mechanisms 2 and 3 to find out all possible pathways as well as the minimum energy reaction pathway. This cooperative mechanism is known to have a lower activation energy compared to that of an uncatalyzed mechanism.²¹

In mechanism 1, four different pathways are possible and in mechanisms 2 and 3, only three pathways are possible. This is because a six-membered cyclic TS is possible from **V** in mechanism 1 and a larger cyclic TS which involves additional molecule would not be feasible in mechanisms 2 and 3. The other three pathways in all mechanisms could be divided into three discrete steps. First step is an unimolecular dissociation (UD) of protonated species, **II**, **III** or **IV**. Second step is a nucleophilic addition (NA) of water (or a water analogue) to a carbonium ion and the last step is a proton transfer (PT) from the nucleophile to a leaving group and concomitant cleavage of a leaving group. In the case of PT in water catalytic pathways, two TSs - proton transfer from the attacking water to a solvating water, **W**, and subsequent proton transfer to the leaving group - were located due to the existence of H_3O^+ as a stable molecule in the reaction path. To simplify the reaction profiles only the highest energy TS was used.

AMSOL program (version 5.0)^{22,23} has been used to include the solvent effects qualitatively because an additional water molecule is not enough to interpret the medium effect on the hydrolysis reactions. AMSOL calculations could be done in two different ways - single point and optimization calculations. In the former, solvation energies were calculated using the gas-phase optimized structures and in the latter, all structures were reoptimized in water medium. However, structure reoptimization was not possible due to the size and complexity of the reactions and even with reoptimization, it still causes problems of evaluating force constants.^{22c} We have shown that results from the single point calculation did give negligible deviation (< 3%) from those of the optimization calculation.²⁴ Therefore, single point calculations were performed at the gas-phase optimized structures (SM3.1²⁵/PM3//PM3) in this study.

Since the error in the heat of formation of H^+ is very large (-12.1 kcal/mol)^{17c} in the gas phase and is *unknown* in solution phase, H_3O^+ is used as a proton source (error : 20.2 kcal/mol (gas)^{17c}, 1.2 kcal/mol (solution)²⁵). Therefore, the energy profiles for mechanisms 1 and 2 were drawn from the heats of formation of the species shown in eq 2.

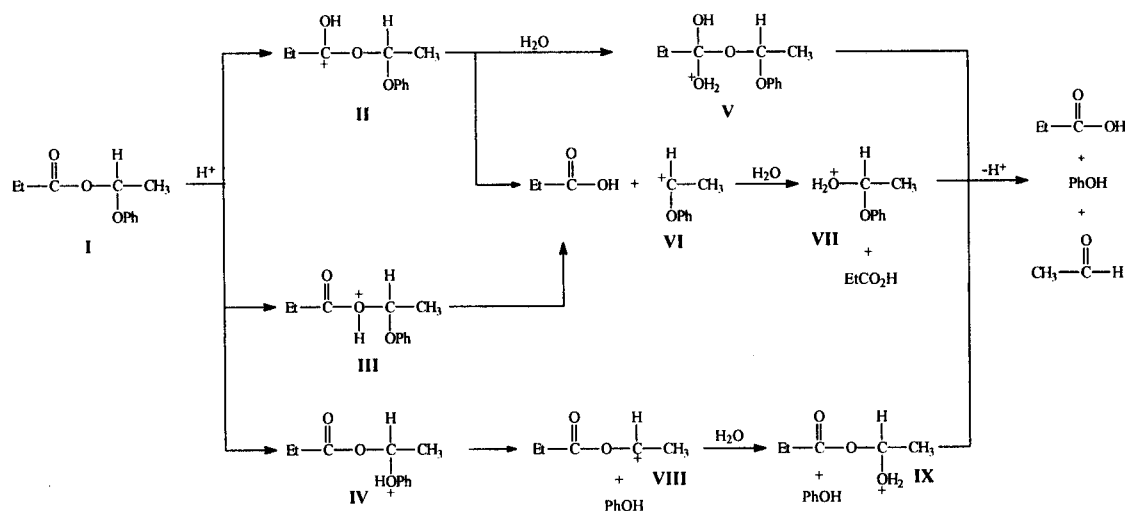

Scheme 1

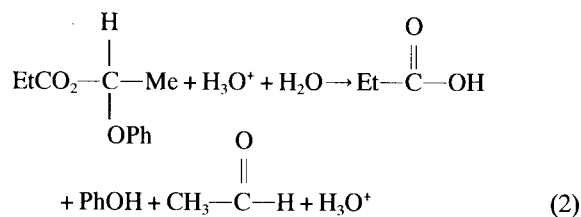

Results and Discussion

Hydrolysis of the protonated species is divided into three different mechanisms depending on the nucleophiles involved in the second stage of the reaction.

Mechanism 1: reactions with one water molecule in the gas phase. Reactant, I, and possible reaction pathways from three protonated species, II, III and IV were depicted in scheme 1. Two pathways are possible from II. In the first pathway, a water molecule attacked the positive carbon center and subsequent 1,5-(O,O)-H transfer (TS1) from water to phenolic oxygen atom formed the final products - propionic acid, phenol, and acetaldehyde. Pathway 2 consists of three steps: unimolecular O-alkyl cleavage of II (TS2) forming a propionic acid and VI followed by the nucleophilic addition (TS3) of H₂O forming VII and the final products were formed via an 1,3-(O,O)-H shift (TS4). First step of the pathway 3 is a unimolecular O-alkyl cleavage (TS5) of III forming the same products

Table 1. PM3 optimized heats of formation^a of various species in the gas phase and in solution.^{a,b}

	Mechanism 1		Mechanism 2 ^c		Mechanism 3 ^d	
	gas	solution	gas	solution	gas	solution
I	-6.13	-114.72				
II	-47.45	-110.40				
III	-28.16	-88.92				
IV	-30.58	-91.00				
V	-54.86	-110.79				
VI	-48.39	-112.36	-51.88	-113.23	-48.39	-110.62
VII	-36.49	-105.60	-52.35	-117.93	-48.77	-112.80
VIII	-35.80	-111.77	-45.91	-107.60	-46.07	-106.44
IX	-33.86	-109.48	-49.80	-115.73	-48.61	-110.98
TS1	-32.39	-84.01				
TS2	-44.02	-101.19				
TS3	-35.33	-109.29	-48.50	-111.63	-44.11	-108.06
TS4	-13.58	-89.31	-41.03	-101.97	-35.15	-87.55
TS5	-27.88	-87.62				
TS6	-30.12	-90.74				
TS7	-32.21	-106.35	-43.86	-105.74	-44.00	-103.57
TS8	-9.48	-83.83	-39.41	-97.33	-33.23	-86.85

^a in kcal/mol. Values not shown in the table are the same as those in Mechanism 1. ^b Sum of heat of formation (ΔH_f) and solvation free energy (ΔG_{sol}). ^c W should be added to the label of each structure. ^d P should be added to the label of each structure.

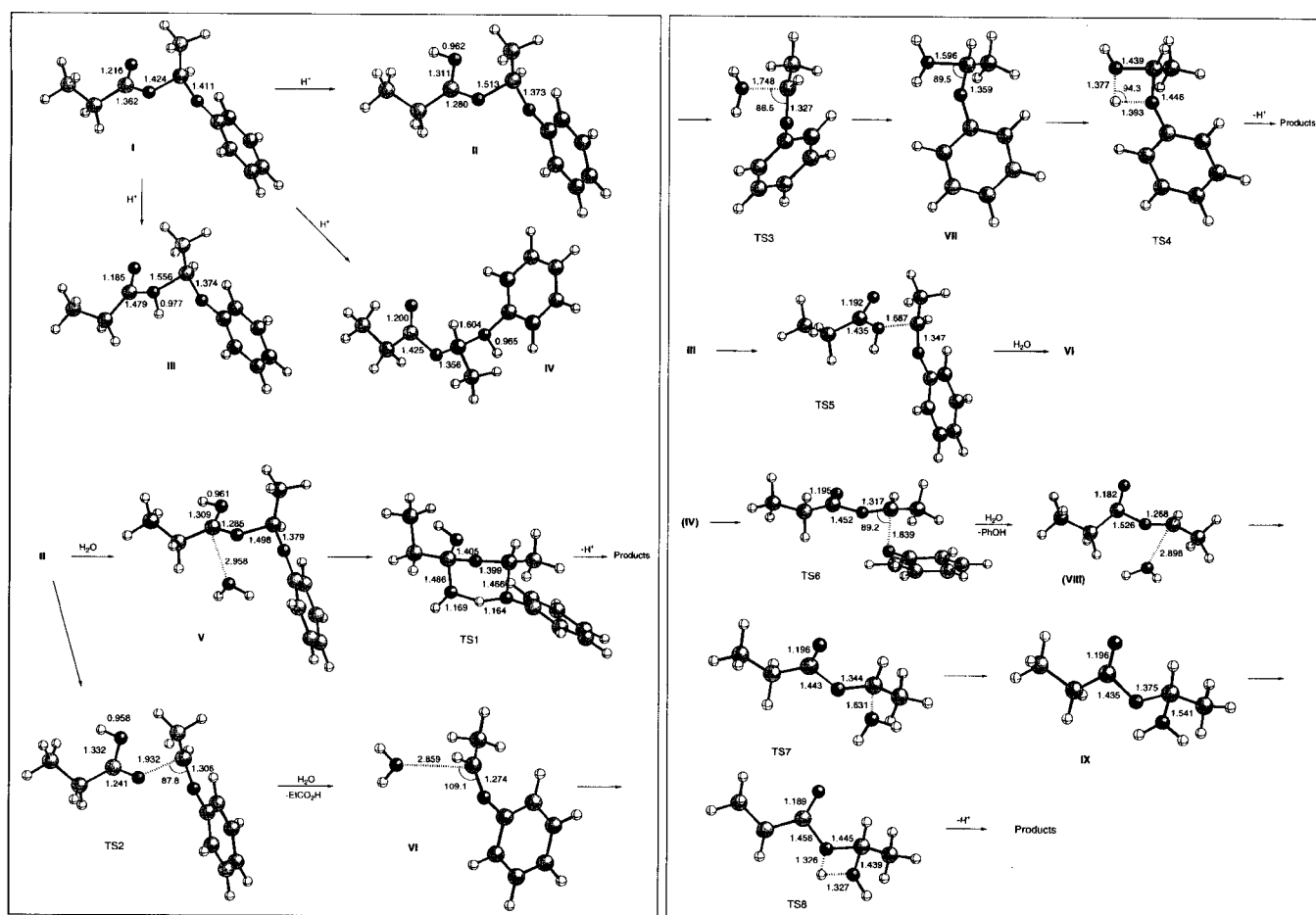

Figure 1. Geometries of stationary points involved in mechanism 1. Bond lengths are in Å and angles in degree.

produced in the first step of pathway 2 and thus the rest of the steps should be the same as those of pathway 2. In the case of **IV**, **VIII** and phenol are formed by the unimolecular dissociation (TS6) followed by addition of H₂O (TS7) and 1,3-(O,O)-H shift (TS8). PM3 heats of formation are summarized in Table 1 and optimized structures for mechanism 1 are shown in Figure 1. Note that **VI** and **VIII** refer to a complex between a carbonium ion and water. Heats of formation shown in Table 1 require special attention. If a stationary point consists of one molecule, the value shown in Table 1 corresponds to the heat of formation of that molecule. If several molecules are involved, the value refers to the sum of all species. For example, -48.39 kcal/mol (**V**) is actually sum of the heats of formation of **VI**-H₂O and ethanoic acid. This enables us to compare the heats of formation directly from the values shown in Table 1.

Since three pathways had similar steps in common, it would be interesting to check the geometrical features all together. In the UD steps, the cleaving C-O bond length changes from 1.5 Å~1.6 Å to 1.7 Å~1.9 Å (TS2, TS5 and TS6). In the NA step, bond length between an oxygen atom of water and the carbonium centre is 1.63 Å (TS7)~1.74 Å (TS3) at the TS and decreases to 1.5 Å~1.6 Å in the products. Moving protons in the PT TSs are almost equally located between both oxygen atoms (1.4 Å at TS4 and 1.3 Å at TS8). In the first pathway, however, **V** is a loose complex between **II** and H₂O with C...O bond length of 2.96 Å and TS1 is a chair-like 6-membered TS with the moving H located in the middle of both oxygen atoms. Notice that the O-H bond lengths (1.2 Å) in TS1 are considerably shorter than those in TS4 or TS8.

Using the computational results from Table 1, energy profile for the formation of final products from four different pathways is depicted in Figure 2. Protonation of **I** in the gas phase is exothermic irrespective of the product cations and protonation to the carbonyl oxygen produces the most stable cation, **II**. Activation energies of four pathways were calculated starting from the stable structure of each elementary step. In pathway 1, **V** was formed from **II** without any barrier and the activation energy to the products is ca. 22 kcal/mol from **V**. In pathway 2, three TSs corresponding to the UD, the NA and 4-membered PT were identified and each step requires 3.4, 13.1 and 22.9 kcal/mol, respectively. In pathway 3, UD of C-O bond requires only 0.3 kcal/mol and the activation energies for

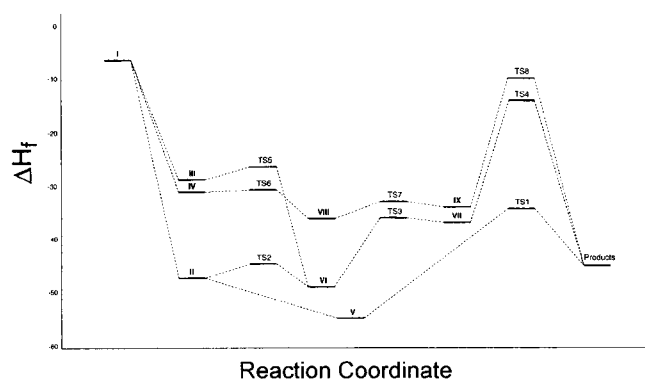

Figure 2. Potential energy profile of mechanism 1.

the remaining steps are the same as those in pathway 2. In pathway 4, same numbers of TSs were located as pathway 2 and each step requires 0.5, 3.6 and 24.4 kcal/mol, respectively. We can easily find that the activation barriers for the PT steps are higher than those for the UD or the NA steps.

Mechanism 2: reactions with water dimer in the gas phase. Several different species can exist in water²⁶ and the simplest one - water dimer - is considered in the calculation. PM3 method was selected because the structural feature of a linear O-H...O bond is well represented using this method.^{17b} Water dimer is used in mechanism 2 because the rate determining steps in pathways 2~4 are the 4-membered PT steps and these higher activation barriers could be lowered by forming a larger cyclic TS with the aid of additional water molecule. Catalytic effect by water dimer could be classified into to 2 classes - active and passive catalyses. In the former case, an additional water can help to form a strain-free cyclic TS and in the latter case, it can lower the energy barrier by dispersing positive charges developed at the TS. In mechanism 2 we can easily observe both catalyses - active in the PT steps and passive in the NA steps.

PM3 optimized structures and potential energy profile are shown in Figures 3 and 4, respectively. In order to specify the involvement of an additional water molecule, W is added to the nomenclature, for example, pathway 1 is labelled pathway 1-W and TS2 is labelled TS2-W. As mentioned earlier, pathway 1-W is not considered in the

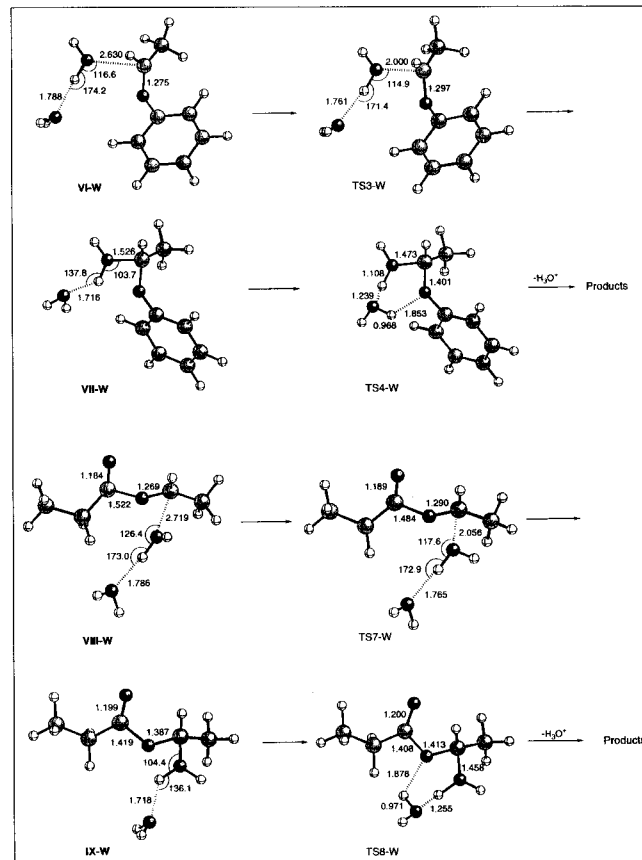

Figure 3. Geometries of stationary points involved in mechanism 2. Bond lengths are in Å and angles in degree.

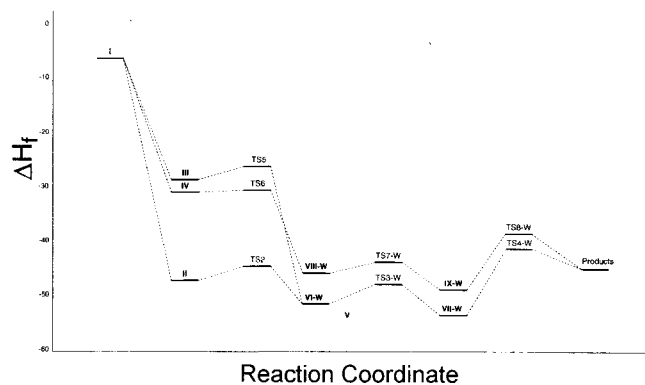

Figure 4. Potential energy profile of mechanism 2.

catalytic pathway. In pathway 2-W, the UD step did not change from pathway 2. The heat of formation of VI-W is *ca.* 3.5 kcal/mol lower than that of VI+H₂O, which comes from the dimerization energy of water dimer, suggesting little change in the structural parameters. In fact, C---O bond length was shortened by 0.2 Å and the remaining parameters did not change much. However, W played an important role in the NA step. TS3-W is *ca.* 13 kcal/mol lower than TS3 and the forming C--O bond becomes longer. This effect comes from the charge dispersal by the W. For example, group charge of the nucleophilic water decreases from 0.27 (TS3) to 0.10 (TS3-W). This is an example of passive catalysis by one water molecule. In the case of the PT step, energy lowering from TS4 to TS4-W is much greater, *ca.* 27 kcal/mol, which is strong evidence for active catalysis by reducing the ring strain of TS4. Geometrical changes for pathway 4-W were similar to those for pathway 2-W. Similarly, the barrier for the PT step decreases by *ca.* 30 kcal/mol while the barrier for the NA step decreases only by 12 kcal/mol.

Mechanism 3: reactions involving intermediate products in the gas phase. In pathways 2 (and 3) and 4, propionic acid and phenol are formed as an intermediate products, respectively, and they can act as a bifunctional catalyst due to the presence of an O-H group like H₂O. In order to include this possibility, propionic acid or phenol (labelled P) was used instead of W in pathways 2-P (and 3-P) and 4-P, respectively. Optimized structures and energy profile are depicted in Figures 5 and 6, respectively. Since the UD steps did not change and final two steps of pathway 3-P are the same as those of pathway 2-P, we only considered two pathways - pathways 2-P and 4-P. P could lower the activation energies in the NA steps by charge dispersal and in the PT steps by reducing the ring strain similar to the catalytic effects found in mechanism 1. Comparison with mechanism 2 shows that the activation energy did not change much in the NA steps, but it did increase from 11.3 kcal/mol (2-W) to 14.6 kcal/mol (2-P) and 10.4 kcal/mol (4-W) to 15.4 kcal/mol (4-P) in the PT steps. This suggests that P can act as an electron acceptor not as an efficient bifunctional catalyst.

Minimum energy reaction pathway in the gas phase. Acid-catalyzed hydrolysis of I can proceed through several different pathways. In mechanism 1, pathway 1 is the most favourable because the other pathways have higher energy intermediates and 4-

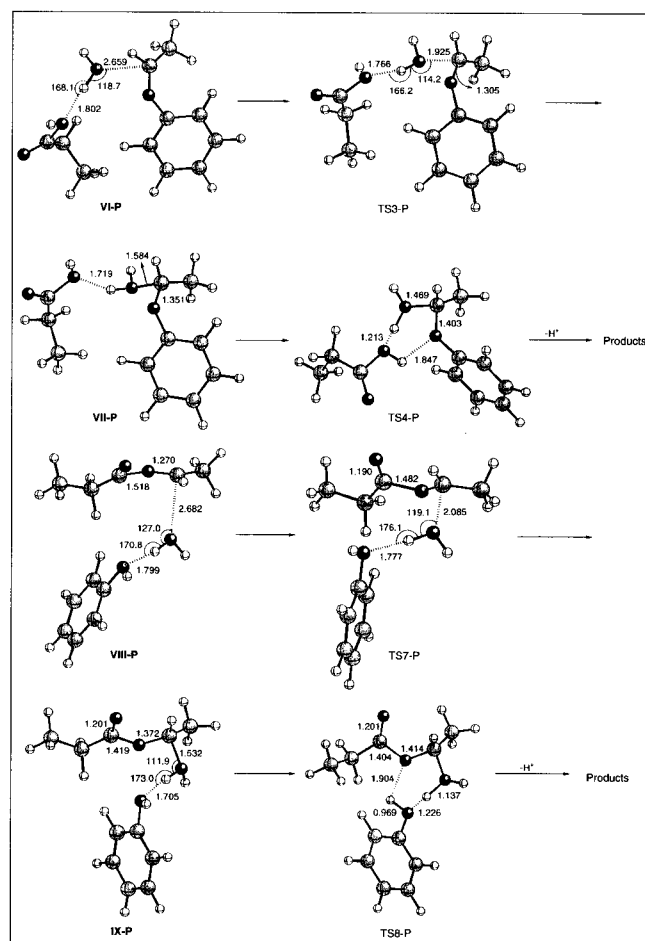

Figure 5. Geometries of stationary points involved in mechanism 3. Bond lengths are in Å and angles in degree.

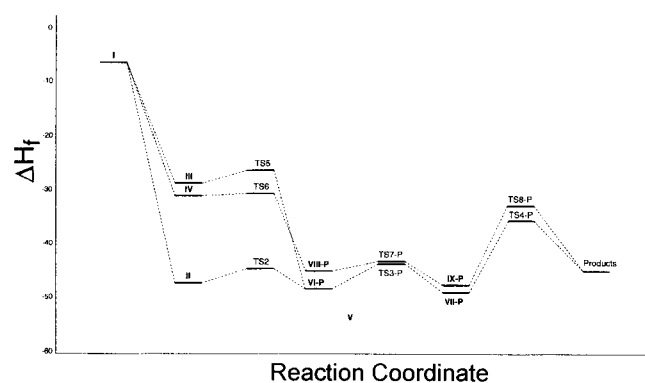

Figure 6. Potential energy profile of mechanism 3.

membered TSs. This is in quite contrast to the experimental results by C. D. Hall.⁶ In order to improve computational method, mechanisms involving an additional molecule (W or P) as a catalyst were also investigated. W is much better catalyst than P because of the amphoteric nature of water molecule. Comparison of activation energies shows that pathway 2-W (or 3-W) is the lowest energy pathway.

Pathways 2 and 3 start from two different cations, II and III, respectively, and proceed through the same steps after the UD step. Since the former is formed by the protonation on carbonyl oxygen and the latter by the protonation on ether oxygen, they will have different stability. In fact,

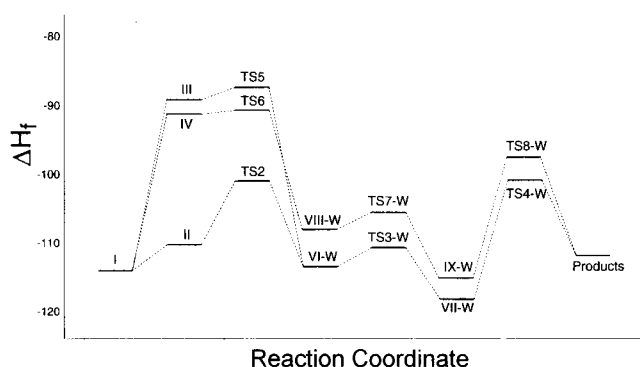

Figure 7. Potential energy profile of mechanism 2 using the SM3.1/PM3/PM3 method.

Table 1 shows that **II** is more stable than **III** by 19 kcal/mol. This means that the minimum energy reaction pathway from **I** in the gas phase is pathway 2 which proceeds through carbonium ion **II**. Rate determining step is the 6-membered PT TS (TS4-W). However, this result is not consistent with experimental one - the hydrolysis proceeds through A_{AL} -1 mechanism with O-C cleavage step as a rate determining step. This discrepancy could come from the fact that the PT is fast in solution but slow in the gas phase.

Reactions in solution: SM3.1 study. Single point calculations using PM3-SM3.1 have been performed at the gas-phase optimized geometries. Sum of the heat of formation and solvation free energy for each structure is also summarized in Table 1 and potential energy profile for pathway 2 is depicted in Figure 7. The largest difference between two media is that the protonation step is exothermic in solution phase. This comes from the fact that solvation free energy of a proton ($\Delta G_{sol} = -258$ kcal/mol at PM3-SM3.1) is much greater than those of other species involved in the reactions, and thus enables us to discuss the hydrolysis in solution qualitatively. Stability of the initial cations in solution decreases in the order of **II** > **IV** > **III**, which is the same order what was found in the gas phase. The PT steps in solution still have the highest activation barrier, which is the same trends found in the gas-phase results. In mechanism 1, pathway 2 is the lowest energy pathway and this is in contrast to the gas-phase result. Proton transfer step, TS4, is the rate determining step in mechanism 1.

No changes were observed in the stability of cations formed in the first steps and also in the rate limiting step in mechanism 2. Most favorable pathway is pathway 2. However, the energy difference between TS2 and TS4-W is negligibly small (0.2 kcal/mol) which is a good indication that two steps are competitive in solution. In mechanism 3, similar trends were also found.

Conclusion

Following results have been observed from the hydrolyses of 1-aryloxyethyl alkanoate in gas- and solution phases.

(1) In the gas-phase reaction, pathway 2-W is the minimum energy reaction path and the step through TS4-W is rate limiting. In solution phase reaction, pathway 2-W is also MERP and the UD and the PT steps are competitive.

(2) Protonation step is endothermic in the gas phase, but exothermic in water solution. Changes in reaction enthalpy also affect the stabilities of the transition states as well as intermediate products.

(3) Inclusion of an addition molecule (W or P) lowers the activation energies by dispersing the positive charge (passive catalysis) or reducing the ring strain (active catalysis) of the TS. The catalytic effect is at maximum in the case of mechanism 2.

(4) Stability of the cations generated from **I** decreases in the order of **II** > **IV** > **III** and this is in accord with the experimental finding of easy protonation on carbonyl oxygen.

Acknowledgment. This work was supported by the Ministry of Education, Korea (BSRI-97-3428) and MOST-FOTD project.

References

- Capon, B. *Chem. Rev.* **1969**, 69, 407.
- (a) File, T. H. *Adv. Phys. Org. Chem.* **1975**, 11, 108. (b) File, T. H. *J. Am. Chem. Soc.* **1965**, 87, 271.
- March, J. *Advanced Organic Chemistry: reactions, mechanisms, and structure*; 4th ed.; John Wiley & Sons, Inc.: 1992; p 380.
- McClelland, R. A. *Can. J. Chem.* **1975**, 53, 2763.
- Cox, R. A.; Yates, J. J. *Org. Chem.* **1986**, 51, 3619.
- Hall, C. D.; Goulding, C. W. *J. Chem. Soc. Perkin Trans. 2* **1995**, 1471.
- (a) Risley, J. M.; Van Etten, R. L. *J. Am. Chem. Soc.* **1979**, 101, 252. (b) Vederas, J. C. *J. Am. Chem. Soc.* **1980**, 102, 374.
- Bunton, C. A.; Spatcher, D. P. *J. Am. Chem. Soc.* **1956**, 78, 1079.
- Salomaa, P. *Acta Chem. Scand.* **1957**, 11, 141; 235; 239.
- (a) Salomaa, P.; Laiho, S. *Acta Chem. Scand.* **1963**, 17, 103. (b) Salomaa, P. *Soumen Kemistilehti* **1964**, B37, 86. (c) Salomaa, P.; Sallinen, K. S. *Acta Chem. Scand.* **1965**, 19, 1054.
- Weeks, D. P.; Zuorick, G. W. *J. Am. Chem. Soc.* **1969**, 91, 477.
- (a) Weeks, D. P.; Grodski, A.; Fauncci, R. *J. Am. Chem. Soc.* **1968**, 90, 4958. (b) Weeks, D. P.; Cella, J.; Chen, L. T. *J. Org. Chem.* **1972**, 38, 3383.
- Gould, E. S. *Mechanism and Structure in Organic Chemistry*, 2nd ed.; New York Press: 1965.
- Issacs, N. S. *Physical Organic Chemistry*, Longman, 1987, ch. 7.
- Johnson, S. L. *Adv. Phys. Org. Chem.* **1967**, 5, 281.
- (a) Kirsch, J. F.; Jencks, W. P. *J. Am. Chem. Soc.* **1964**, 86, 833. (b) Lee, I.; Kim, C. K.; Lee, B.-S.; Ha, T.-K. *J. Mol. Struct. (Theochem)* **1990**, 208, 91.
- (a) Stewart, J. J. P. *J. Comput. Chem.* **1989**, 10, 209. (b) Stewart, J. J. P. *J. Comput. Chem.* **1989**, 10, 221. (c) MOPAC93 Manual, Revision Number 2, Stewart, J. J. P. Fujitsu Limited, 1994.
- MOPAC 6.0 program, available from Quantum Chemistry Program Exchange (QCPE), No. 506.
- J. Baker, *J. Comput. Chem.* **1986**, 7, 385.
- (a) Muller, K. *Angew. Chem.* **1980**, 19, 1. (b) Bell, S.; Crighton, J. S. *J. Chem. Phys.* **1984**, 80, 2464.

21. (a) Bell, R. P. *Adv. Phys. Org. Chem.* **1966**, 4, 1. (b) Eigen, M. *Discuss. Faraday Soc.* **1965**, 39, 7. (c) Madura, J. M.; Jorgensen, W. L. *J. Am. Chem. Soc.* **1986**, 108, 2517. (d) Ventura, O. N.; Coitino, E. L.; Irving, K.; Iglesias, A. *J. Mol. Struct. (Theochem)* **1990**, 210, 427. (e) Peeters, D.; Leroy, G. *Can. J. Chem.* **1991**, 69, 1376. (f) Ventura, O. N.; Apostolova, E. S. *Int. J. Quantum Chem.* **1991**, 40, 425. (g) Wolfe, S.; Kim, C.-K.; Yang, K.; Weinberg, N.; Shi, Z. *J. Am. Chem. Soc.* **1995**, 117, 4240.
22. (a) Cramer, C. J.; Truhlar, D. G. *J. Am. Chem. Soc.* **1991**, 113, 8552. (b) AMSOL 5.0 program, available from Quantum Chemistry Program Exchange (QCPE), No. 606. (c) for example, see Klamt, A.; Schuurmann, G. *J. Chem. Soc. Perkin Trans. 2* **1993**, 799.
23. Cramer, C. J.; Truhlar, D. G. *J. Comput. Chem.* **1992**, 13, 1089.
24. Lee, I.; Kim, C. K.; Lee, B.-S.; Kim, C. K.; Lee, H. W.; Han, I. S. *J. Phys. Org. Chem.* **1997**, 10, 908.
25. Liotard, D. A.; Hawkins, G. D.; Lynch, G. C.; Cramer, C. J.; Truhlar, D. G. *J. Comput. Chem.* **1995**, 16, 422.
26. (a) Benson, S. W. *J. Am. Chem. Soc.* **1978**, 100, 5640. (b) Benson, S. W.; Siebert, E. D. *J. Am. Chem. Soc.* **1992**, 114, 4269. (c) Clementi, E.; Corongiu, G. in *Structure and Reactivity in Aqueous Solution: Characterization of Chemical and Biological Systems*; Cramer, C. J.; Truhlar, D. G. Ed., ACS Symposium Series 568, Ch. 7. American Chemical Society, Washington DC, 1994.