

6.2-6.3 (m, 2H, CH=CH-CH=CH), 7.2-7.3 (m, 2H, CH=CH-CH=CH). UV: λ_{\max} =264 nm, methanol, ϵ =31100. Differential Scanning Calorimetry (DSC): main phase transition temperature=79 °C at the maximum excess heat capacity in PBS.

- Okahata, Y.; Kunitake, T. *J. Am. Chem. Soc.* **1979**, *101*, 5231.
- Bader, H.; Ringsdorf, H. *J. Polym. Sci., Polym. Chem. Ed.* **1982**, *20*, 1623.
- MacDonald, R. I.; MacDonald, R. C. *Biochim. Biophys. Acta* **1983**, *735*, 243.
- Kolchens, S.; Ramaswami, V.; Birgenheier, J.; Nett, L.; O'Brien, D. F. *Chem. Phys. Lipids* **1993**, *65*, 1.
- Liu, D.; Huang, L. *Biochim. Biophys. Acta* **1989**, *981*, 254.
- Leventis, R.; Diavoco, T.; Silvius, J. *Biochemistry* **1987**, *26*, 3267.
- Bader, H.; Ringsdorf, H. *Faraday Discuss. Chem. Soc.* **1986**, *81*, 329.
- Moss, R. A.; Fujita, T.; Okumura, Y. *Langmuir* **1991**, *7*, 2415.

The Relative Reactivity of Palladium towards Migration and Ring-Opening of Three- and Four-Membered Ring Alkanes and Ethers

Richard C. Larock* and Hanchul Song†

*Department of Chemistry,
Iowa State University,
Ames, Iowa 50011, USA

†Department of Dyeing and Finishing,
Kyungpook National University,
Taegu 702-701, Korea

Received June 15, 1996

Vinylcyclopropanes¹ and methylene cyclopropanes² have been ring-opened by palladium(0) reagents and palladium dichloride. Vinylic epoxides³ and oxetanes⁴ also undergo palladium(0) catalyzed ring-opening reactions useful in organic synthesis. We and others have recently observed that the addition of organopalladium compounds to unsaturated epoxides⁵ and oxetanes,⁶ as well as unsaturated cyclopropanes and cyclobutanes,⁷ leads via facile ring-opening to high yields of unsaturated alcohols and π -allylpalladium compounds respectively (eqs. 1, 2). Since the mechanism we proposed for

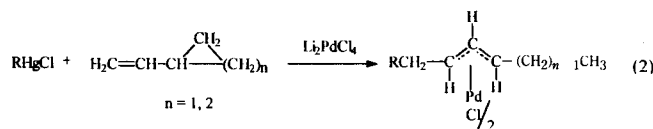
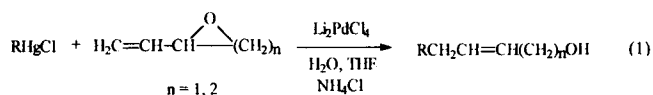

these processes had little literature precedent,^{2h-j,7c,8} we sought further information on these reactions. In conjunction with our earlier reported method for the preparation of π -allylpalladium compounds from Li_2PdCl_4 , vinylmercurials and alkenes (eq. 3),⁹ we have now studied the relative reactivity of palladium towards migration (eq. 3) and the ring-opening of three- and four-membered ring alkanes and ethers (eqs. 1, 2).

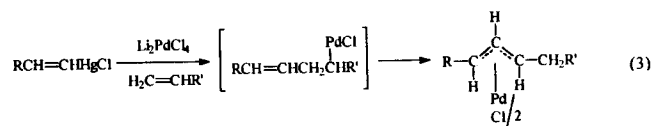

Vinylmercurial **1** reacts with Li_2PdCl_4 and vinylcyclopropane or 3,4-epoxy-1-butene to give predominantly the corresponding ring-opened π -allylpalladium compound **2**⁷ and dienol **3**⁵ respectively (eqs. 4, 5), while vinylcyclobutane affords only the migration product **4** (eq. 6). X-ray crystallographic analysis¹⁰ of dimer **4** (Figure 1) indicates a crystallographic 2-fold axis passing through the chlorine atoms. This is the first example, to our knowledge, of such symmetry in a π -allylpalladium dimer. All bond angles and distances are within the range expected. Compound **4** adopts a "transplanar" arrangement in which the cyclobutyl rings appear to be only slightly puckered (± 0.06 Å)

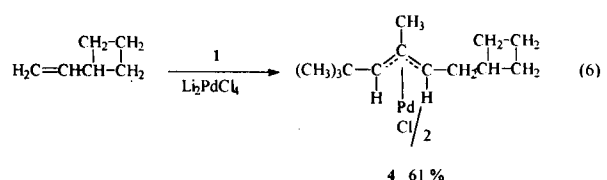
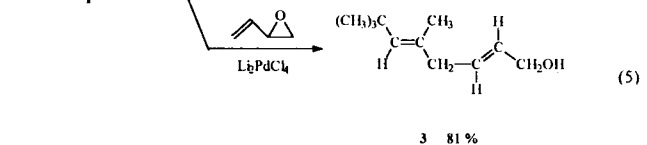
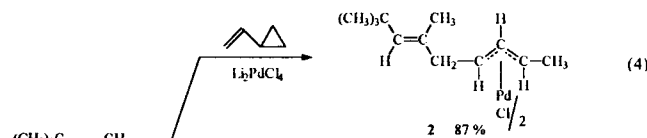

Vinyl oxetane **5** has been observed to afford comparable amounts of ring-opened dienol **6** and π -allylpalladium migration product **7** (eq. 7)⁶

Consistent with the higher reactivity of the cyclopropane versus the cyclobutane in vinylcyclopropane and vinylcyclobutane, the reaction of phenylmercuric chloride, Li_2PdCl_4 and 1-cyclobutyl-1-cyclopropylethene afforded only a syn-anti mixture of the cyclopropane-opened products **8** (eq. 8).

We have established the ability of palladium to migrate prior to ring-opening by obtaining π -allylpalladium compound **9** from the reaction of phenylmercuric chloride, Li_2PdCl_4 and allylcyclopropane (eq. 9). On the other hand, the reaction of vinylmercurial **1**, Li_2PdCl_4 and allylcyclopropane gives two

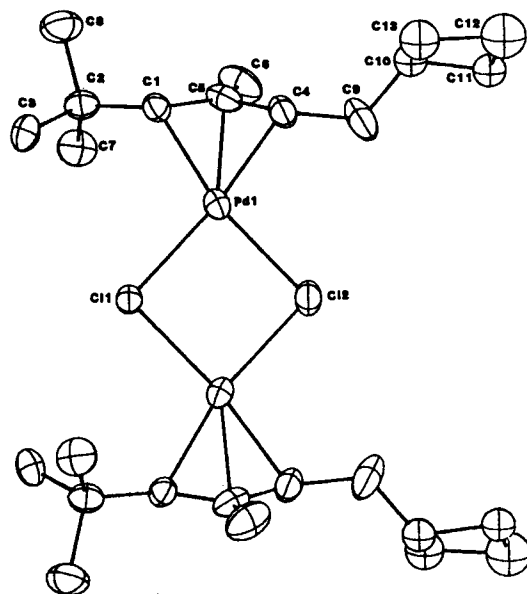
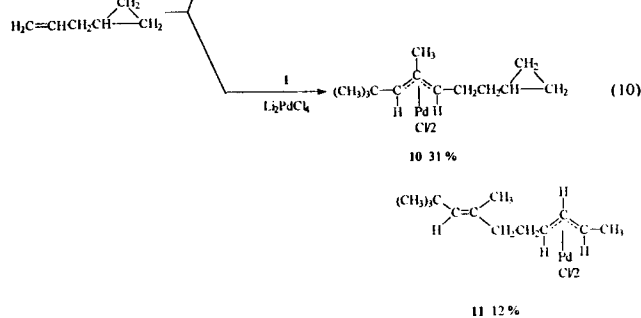
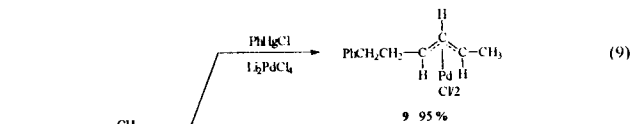
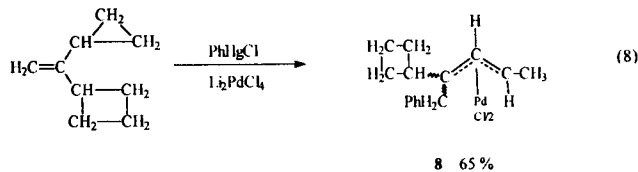
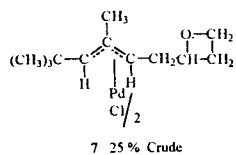
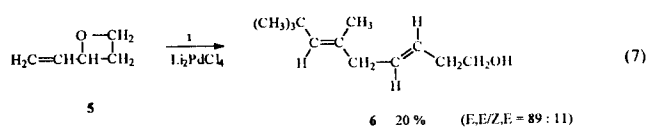
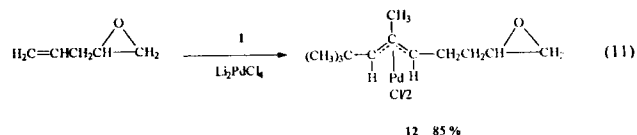

Figure 1. An ORTEP drawing of compound **4**. Hydrogen atoms are omitted for clarity. Selected (average) distances and angles are: Pd-Cl=2.421 Å, Pd-C(allyl)=2.119 Å, C-C(allyl)=1.405 Å; Cl-Pd-Cl=86.2°, Pd-Cl-Pd=93.8°, C-C-C(allyl)=113.6°.



products, π -allylpalladium compounds **10** and **11** resulting from migration and ring-opening respectively (eq. 10).

The reaction of vinylmercurial **1**, Li_2PdCl_4 and 4,5-epoxy-pentene proceeds by palladium hydride migration to afford π -allylpalladium compound **12** (eq. 11).¹¹



While all these reactions have not been carried out under identical reaction conditions, we conclude that the relative reactivity towards palladium-promoted ring-opening is approximately cyclopropane > epoxide > oxetane > cyclobutane.

Acknowledgment. We gratefully acknowledge the National Institutes of Health (GM24254) and the Petroleum Research Fund administered by American Chemical Society (PRF 16396-ACI) for financial support; Johnson Matthey, Inc. and Kawaken Fine Chemicals Co., Ltd. for generous loans of palladium chloride; and J. E. Benson for the X-ray crystallographic determination.

References

- (a) Morizawa, Y.; Oshima, K.; Nozaki, H. *Tetrahedron Lett.* **1982**, 23, 2871. (b) Chiusoli, G. P.; Costa, M.; Pallini, L.; Terenghi, G. *Transition Met. Chem. (Weinheim, Ger.)* **1982**, 7, 304. (c) Ketley, A. D.; Braatz, J. A. *J. Organomet. Chem.* **1967**, 9, p 5. (d) Shono, T.; Yoshimura, T.; Matsu-mura, Y.; Oda, R. *J. Org. Chem.* **1968**, 33, 876. (e) Ahmad, M. U.; Bäckvall, J.-E.; Nördberg, R. E.; Norin, T.; Strom-berg, S. *J. Chem. Soc., Chem. Commun.* **1982**, 321. (f) Bäckvall, J.-E.; Björkman, E. E. *J. Chem. Soc., Chem. Commun.* **1982**, 693. (g) Wilhelm, D.; Bäckvall, J.-E.; Nörd-berg, R. E.; Norin, T. *Organometallics* **1985**, 4, 1296.
- (a) Binger, P.; Schuchardt, U. *Chem. Ber.* **1980**, 113, 1063, 3334, **1981**, 114, 3313. (b) Binger, P.; Germer, A. *Chem. Ber.* **1981**, 114, 3325. (c) Binger, P.; Cetinkaya, M.; Doyle, M. J.; Germer, A.; Schuchardt, U. in *Fundamental Research in Homogeneous Catalysis*; Tsutsui, M. Ed.; Plenum: New York, Vol 3. **1979**. (d) Binger, P.; Schuchardt, U. *Angew. Chem., Int. Ed. Engl.* **1977**, 16, 249. (e) Hughes, R. P.; Hunton, D. E.; Schumann, K. *J. Organomet. Chem.* **1979**, 169, C37. (f) Noyori, R.; Takaya, H. *J. Chem. Soc. D*, **1969**, 525. (g) Dallas, B. K.; Hughes, R. P. *J. Organomet. Chem.* **1980**, 184, C67. (h) Green, M.; Hughes, R. P. *J. Chem. Soc., Chem. Commun.* **1974**, 686. (i) Green, M.; Hughes, R. P. *J. Chem. Soc., Dalton Trans* **1976**, 1890.
- (a) Tsuji, J.; Kataoka, H.; Kobayashi, Y. *Tetrahedron Lett.* **1981**, 22, 2575. (b) Trost, B. M.; Molander, G. A. *J. Am. Chem. Soc.* **1981**, 103, 5969. (c) Trost, B. M.; Warner, R. W. *J. Am. Chem. Soc.* **1982**, 104, 6112. (d) Takahashi, T.; Kataoka, H.; Tsuji, J. *J. Am. Chem. Soc.* **1983**, 105, 147. (e) Wicha, J.; Kabat, M. M. *J. Chem. Soc., Chem. Commun.* **1983**, 985. (f) Trost, B. M.; Warner, R. W. *J. Am. Chem. Soc.* **1983**, 105, 5940. (g) Takahashi, T.; Ootake A.; Tsuji, J. *Tetrahedron Lett.* **1984**, 25, 1921. (h) Ognynov, V. I.; Hesse, M. *Synthesis* **1985**, 645. (i) Stach, H.; Hesse, M. *Helv. Chim. Acta*, **1986**, 69, 1614. (j) Trost, B. M.; Urch, C. J.; Hung, M.-H. *Tetrahedron Lett.* **1986**, 27, 4949. (k) Trost, B. M.; Luengo, J. I. *J. Am. Chem. Soc.* **1988**,

- 110, 8239. (l) Bäckvall, J.-E.; Juntunen, S. K. *J. Org. Chem.* **1988**, 53, 343. (n) Deardorff, D. R.; Myles, D. C.; MacFerrin, K. D. *Tetrahedron Lett.* **1985**, 26, 5615. (o) Deardorff, D. R.; Shambayati, S.; Linde, II R. G.; Dunn, Monty M. *J. Org. Chem.* **1988**, 53, 189. (p) Trost, B. M.; Chen, S.-F. *J. Am. Chem. Soc.* **1986**, 108, 6053. (q) Trost, B. M.; Romero, A. G. *J. Org. Chem.* **1986**, 51, 2332. (r) Trost, B. M.; Kuo, G.-H.; Benneche, T. *J. Am. Chem. Soc.* **1988**, 110, 621. (s) Trost, B. M.; Scanlan, T. S. *Tetrahedron Lett.* **1986**, 27, 4141. (t) Trost, B. M.; Hane, J. T.; Metz, P. *Tetrahedron Lett.* **1986**, 27, 5695. (u) Takahashi, T.; Ootake, A.; Tsuji, J.; Tachibana, K. *Tetrahedron* **1985**, 41, 5747. (v) Kende, A. S.; Kaldor, I.; Aslanian, R. *J. Am. Chem. Soc.* **1988**, 110, 6265. (w) Takahashi, T.; Miyazawa, M.; Ueno, H.; Tsuji, J. *Tetrahedron Lett.* **1986**, 27, 3881. (x) Wicha, J.; Kabat, M. M. *J. Chem. Soc., Perkin I*, **1985**, 1601. (y) Echavarren, A. M.; Stille, J. K. *Tetrahedron* **1989**, 45, 979.
- Larock, R. C.; Stolz-Dunn, S. K. *Tetrahedron Lett.* **1989**, 30, 3487.
 - Larock, R. C.; Ilkka, S. J. *Tetrahedron Lett.* **1986**, 27, 2211.
 - Larock, R. C.; Stolz-Dunn, S. K. *Tetrahedron Lett.* **1988**, 29, 5069.
 - (a) Larock, R. C.; Varaprath, S. *J. Org. Chem.* **1984**, 49, 3432. (b) Larock, R. C.; Song, H.; Kim, S.; Jacobson, R. A. *J. Chem. Soc., Chem. Commun.* **1987**, 834. (c) Fischetti, W.; Heck, R. F. *J. Organomet. Chem.* **1985**, 293, 391.
 - Ban, E.; Hughes, R. P.; Powell, J. *J. Organomet. Chem.* **1974**, 69, 455.
 - Larock, R. C.; Mitchell, M. A. *J. Am. Chem. Soc.* **1978**, 100, 180.
 - Crystal data. Pd₂Cl₂C₂₆H₄₆, monoclinic C2/c, Z=4, a=21.631 (4), b=12.308 (2), c=11.375 (3) Å, β=107.55 (2)°, ρ_{calc}=1.468 g/cm³, μ=14.27 cm⁻¹, (MoKα, λ=0.71069 Å, graphite-monochromated). The structure was solved by a heavy atom method and refined to R=0.052 and Rw=0.075 (ω=1/σ_F²) against 1621 observed (I≥3σ_I) reflections. C(10) and C(11) were disordered over two possible configurations with occupancy ratio of 0.61 (3):0.39.
 - Ilkka, S. J., M. S. Thesis, Iowa State University, 1985

A Great Importance of the Acid Additives in Cyclizations via Neopentyl-Type Alkyl Palladium Intermediates

Chang Ho Oh*, Andre Kim, Chul Yun Rhim, Ji Hye Kang, and Bun Seang Park

Department of Chemistry, Inje University,
Kimhae 621-749, Korea

Received June 25, 1996

Effective construction of polycyclic compounds has been a major challenge in synthetic organic chemistry due to the large appearance of biologically active natural products pos-

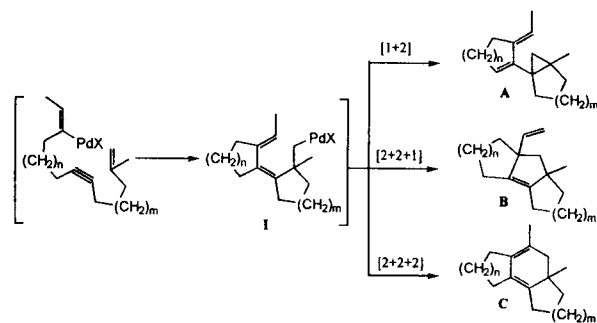

Scheme 1.

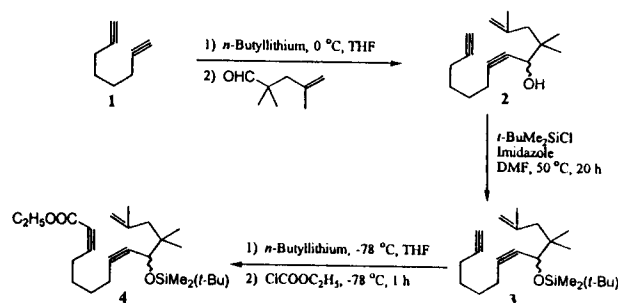

Scheme 2.

sessing polycyclic rings.¹ For the past few years, palladium catalyzed cyclization has emerged as an efficient methodology which can provide various types of cyclic compounds in a very easy one step process.² In connection of our interest in palladium catalyzed enediyne cyclizations forming tricyclic compounds, we have envisioned the feasibility of these regio- and stereo-selective polycyclizations which require to form neopentyl-type alkylpalladium intermediates.³

The neopentyl-type alkylpalladium intermediates (I) having a conjugated diene unit were known to undergo three different types of cyclization to form the corresponding three (A), five (B), and six membered ring (C) depending on reaction conditions and substrates (Scheme 1).⁴ Due to the complexity of these reactions, little attention has been devoted to clarify which factors govern each of these cyclization pathways. In this paper we wish to report an important clue to change those reaction pathways to form chemoselectively either the five-membered ring B or the six-membered ring C. We have prepared simple substrates 3 and 4 shown in Scheme 2. 1,7-Octadiyne (1) was deprotonated with *n*-butyllithium and then condensed with 2,2,5-trimethyl-5-pentenal⁵ in THF to yield the corresponding alcohol 2. The alcohol 2 was protected with *tert*-butyldimethylsilyl chloride to give the substrate 3. Deprotonation of the substrate 3 with *n*-butyllithium and treatment of ethyl chloroformate at -78 °C gave the substrate 4.

Enediyne 3 and 4 serve as our substrates shown in Scheme 3. When a dimethylformamide solution of substrate 3, 5 mol% of π -allylpalladium chloride dimer,⁶ 10 mol% of triphenylphosphine, and 0-5 mol% of acetic acid was stirred for 4 h at 100 °C, the reaction was sluggish to give the corresponding cyclized product 3a in 10-20% yield along with a dimerized product in 40-50% yield.⁷

We have tried to cyclize the substrate 3 using other pala-