

MODIFICATION OF AN ALUMINO-BOROSILICATE GLASS SYSTEM USING CERAMIC ADDITIVES FOR LTCC APPLICATION

JONG-HYUN KIM, SUNG-WOOK KWON, HYUN-TAE KIM, DANG-HYOK YOON*

*School of Materials Science and Engineering, Yeungnam University
Gyeongsan 712-749, Korea*

E-mail: dhyoon@ynu.ac.kr

Submitted December 7, 2007; accepted June 9, 2008

Keywords: Dielectric properties; Mechanical properties; Sintering; Glass ceramics

The effects of CuO, TiO₂ and B₂O₃ additives on the dielectric and mechanical properties of a commercial, lead-free alumino-borosilicate glass and 40 wt. % of Al₂O₃ mixture system were investigated using a full-factorial design of experiments (DOE) technique for low temperature co-fired ceramic (LTCC) application. Sintered density, dielectric constant, and flexural strength were analyzed statistically as output responses for nine sample groups, according to the DOE table, after sintering at 900°C for 40 minutes in air. The optimum composition for this system was found to be the addition of 5 wt. % of CuO, TiO₂, and B₂O₃, which exhibited the dielectric constant of 8.3, relative density of 99%, and flexural strength of 258 MPa. These values were a marked improvement on those of the glass system. Due to the negligible second phase formation and interaction among the input factors associated with this experiment, Lichtenecker's mixing model was confirmed to represent accurately the dielectric constant behavior.

INTRODUCTION

Low temperature co-fired ceramic (LTCC) compositions with a sintering temperature no more than 900°C are in great demand in the field of highly integrated electronic components and modules [1,2]. The LTCC system generally consists of dielectrics and metal electrode such as Ag or Cu with the melting temperature of 961°C and 1083°C, respectively [3]. Most of the ceramics having a high dielectric constant and quality factor require high sintering temperature, while glass-only usually shows a low dielectric constant along with poor mechanical properties. In order to solve this problem, ceramic fillers are usually mixed with glass frits with low melting temperature to make the dielectric system co-firable with metal electrode.

There are mainly two types of LTCC materials system using low-melting glass with ceramic fillers [4]. The first type is based on the little reaction between glass and ceramic fillers, while the glass acts as a bonding agent to hold the ceramic particles together. The second type uses the recrystallization among ceramic and glass ingredients during the firing process, which is known to be suitable for high frequency and low loss application [4]. The overall microstructure, phases and properties are governed by the relative ingredient amounts and sintering conditions for both cases.

Borosilicate glasses are the most commonly used glass materials in glass - ceramic composites for LTCC system [5]. For the first-type dielectric system, Al₂O₃ has been widely used as a ceramic filler due to its avail-

ability and low reactivity with glass [6,7]. Even though it also enhances a mechanical strength and chemical inertness to the dielectric system, Al₂O₃ alone cannot satisfy all of the dielectric and mechanical requirements for LTCC application. On the other hand, it is known that TiO₂ has high dielectric constant along with low loss factor, which can be used to increase the dielectric constant of the system [8]. Moreover, CuO is known to enhance the sintering of TiO₂ by CuO–TiO₂ eutectic formation at 919°C without any intermediate compound [9].

With this background, we tried to synthesize the first-type LTCC system using a commercial alumino-borosilicate by adding four ceramic fillers, Al₂O₃, CuO, TiO₂ and B₂O₃, to satisfy commercial requirements. A full-factorial design of experiments (DOE), which is a powerful tool for establishing relationships between many experimental factors and output responses for a complex system, was utilized [10]. The amounts of CuO, TiO₂ and B₂O₃, which were designated as input factors, were varied in a planned manner, while a fixed amount of Al₂O₃ (40 wt.%) was added to the glass system. The effects of the input factors, i.e., the variation in CuO, TiO₂ and B₂O₃ content, on the sintering, mechanical and dielectric properties were investigated. Moreover, the optimum condition was chosen based on the DOE results, and efforts have been made to explain the behavior of the dielectric constant of composite samples using various traditional mixing models. Finally, the effects of starting materials size on sintering and dielectric properties were investigated for the chosen optimum condition.

EXPERIMENTAL

A commercial, alumino-borosilicate powder (MGG-30, Mirae Materials Co., Korea) with a composition of $15\text{Al}_2\text{O}_3\text{-}10\text{B}_2\text{O}_3\text{-}65\text{SiO}_2\text{-}10$ others in wt.% and with an average particle size of $1.43\ \mu\text{m}$ was used as the glass phase. This glass system has a RoHS compatible Pb-free composition and no alkali metals which are known to cause a problem during plating process due to the catalytic poisoning effect [11]. A fixed 40 wt.% of Al_2O_3 (99.9%, $D_{50} = 1.86\ \mu\text{m}$, ALM-41-01, Sumitomo, Japan) was added to the glass powder. Three other ceramic fillers, CuO (99.9%, $D_{50} = 0.73\ \mu\text{m}$, Kanto Chemical, Japan), B_2O_3 (99.0 %, $D_{50} = 2.25\ \mu\text{m}$, Kanto Chemical, Japan) and TiO_2 (99.0 %, $D_{50} = 0.43\ \mu\text{m}$, rutile form, Kanto Chemical, Japan), were added between 1 and 5 wt.%, according to DOE table shown in Table 1, to give nine samples.

The nine samples were ball-milled in ethanol for 24 hours using 2 mm ZrO_2 balls after adding 0.5 wt.% of phosphate esters-based dispersant (Rhodafac RE-610, Rhodia, Korea) with respect to the powder.

Table 1. Full-factorial design of experimental (DOE) table.

Sample No.	Center point	Experimental factors and levels		
		CuO (wt.%)	TiO_2 (wt.%)	B_2O_3 (wt.%)
1	1	1	1	3
2	1	5	1	3
3	1	1	5	3
4	1	5	5	3
5	1	1	1	5
6	1	5	1	5
7	1	1	5	5
8	1	5	5	5
9	0	3	3	4

These powder mixtures were dried at 100°C overnight, mixed with 0.5 wt.% of polyvinyl alcohol (PVA), and then pressed uniaxially at $250\ \text{kgf/cm}^2$ to form pellets with a diameter of 20 mm and bar-type samples with a dimension of $50.0 \times 5.0 \times 5.0\ \text{mm}$. These samples were sintered at 900°C for 40 minutes in air with a heating rate of 5°C/min .

The pellets were used to measure the sintered density using the Archimedes method and the dielectric properties after screen printing of Ag paste (S-3110, IMD, Korea) for both sides using an impedance/gain-phase analyzer (SI 1260, Solartron, UK) equipped with a dielectric interface and a sample holder (12962A, Solartron, UK). Bar-type samples were utilized to measure the 4-point flexural strength using a screw-driven mechanical test system (Autograph AG-500E, Shimadzu, Japan) with a constant cross head displacement rate of $0.1\ \text{mm/min}$. At least 10 samples for each condition were used for each of the above measurements. In addition, the same tests were performed with the glass system without ceramic fillers. For further characterization, a field emission scanning electron microscope (FESEM: S-4100, Hitachi using 2 kV with the working distance of 5-8 mm) and X-ray diffractometer (XRD: RINT 2000, Rigaku using $\text{Cu K}\alpha$ line, Japan) were used. A statistical analysis software package, MINITAB, was used to generate the DOE table and analyze the results.

After selecting the optimum condition among 9 samples based on DOE results, the starting materials of optimum composition was further milled using high energy mill in order to check the effect of particle size on the overall properties. Figure 1 presents a schematic of (a) high energy mill system (MiniCer, Netzsch, Germany) and (b) the grinding chamber of this mill. This mill had a ZrO_2 lining with an 180cc of milling chamber which was filled with 80 vol. % of $0.45\ \text{mm}$ ZrO_2 balls.

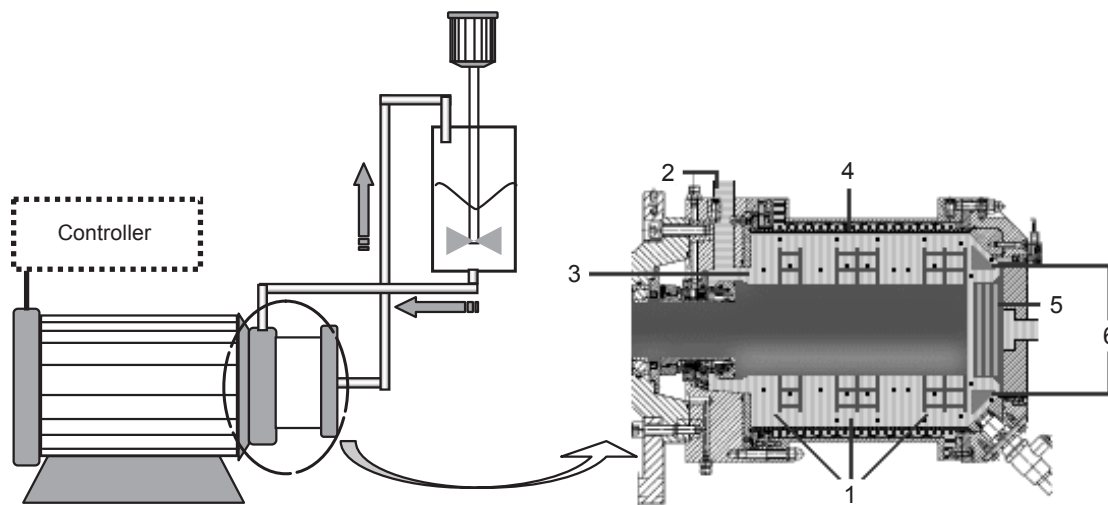
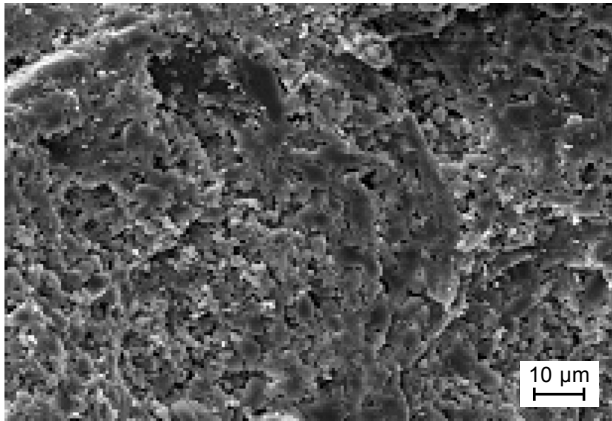
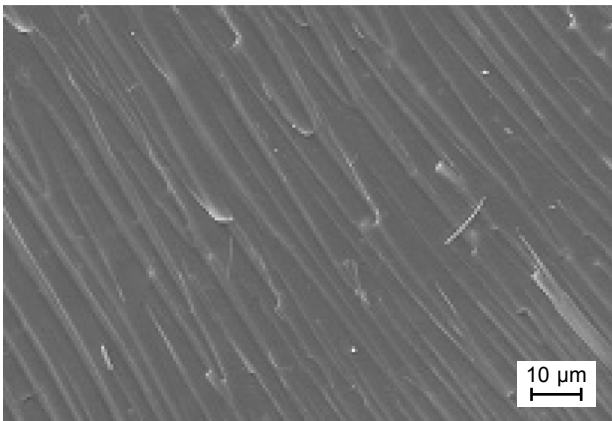

Figure 1. Schematic of (a) high energy mill and (b) the milling chamber of the high energy mill [12]. 1: Rotor with discs, 2: inlet, 3: milling media, 4: cooling jacket, 5 and 6: separation system.

High energy milling was performed at 3 000 rpm for 2 hours for 176 grams of starting materials by adopting a continuous circulation method. The same sample preparation and characterization were followed for the samples exposed to the sintering at 860, 880, 900, and 920°C for 40 minutes in air.



a)



b)

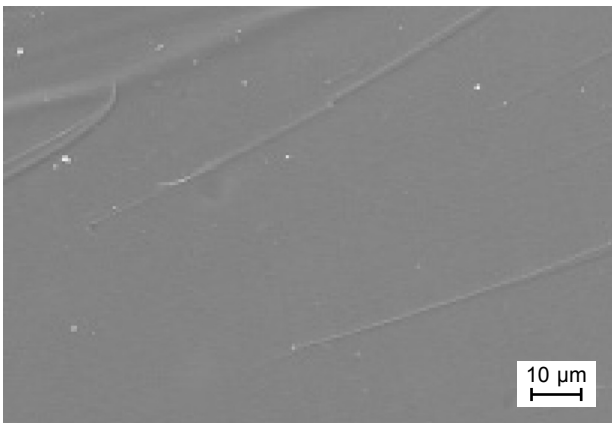

c)

Figure 2. FESEM morphologies of the fractured surface for glass-only MGG-30 sintered at different temperatures: a) 850°C, b) 900°C and c) 950°C.

RESULTS AND DISCUSSION

The alumino-borosilicate powder used in this study starts to be recrystallized at approximately 900°C and turns to a homogeneous phase at 950°C as shown in Figure 2, indicating its adequate sintering temperature of higher than 900°C. The 900°C-sintered glass showed the bulk density of 2.36 g/cm³ with a partly vitrified morphology, dielectric constant of 6.25 at 1 MHz, and flexural strength of 170 MPa based on the preliminary test. The LTCC manufacturer recommends the following properties as being desirable for actual application of this powder: sintering temperature no more than 900°C, dielectric constant around 8.0 at 1 MHz and the flexural strength higher than 200 MPa.

After adding 40 wt. % of Al₂O₃ to the glass powder, the amounts of CuO, TiO₂ and B₂O₃ with respect to the glass-Al₂O₃ composite weight were varied to improve the dielectric and mechanical properties, as shown in Table 1. Sample No. 9 corresponds to the center point which has the mid-value of each input factor's level to establish the existence of curvature in the output response.

Figure 3 shows the XRD patterns of selected DOE samples and glass-only MGG-30 after sintering at 900°C for 40 min. MGG-30 showed a broad maximum, indicating the existence of an amorphous glass phase, while all of the selected DOE samples showed sharp peaks due to the existence of most of ceramic fillers as the original phase without any significant second phase formation. Recrystallization of SiO₂ phase was notable for all DOE samples with a small XRD peak at 2θ of 21° except for MGG-30, indicating the certain degree of recrystallization of constituents during sintering process. Figure 4 represents the fractured surface mor-

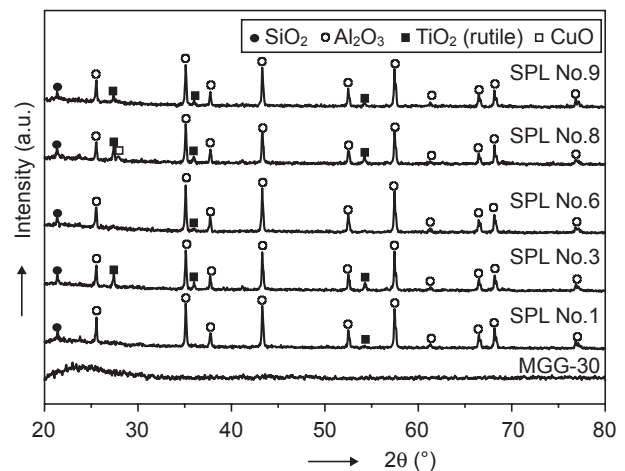
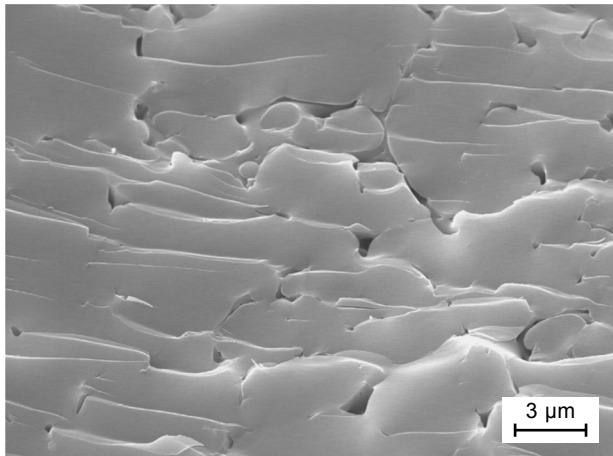
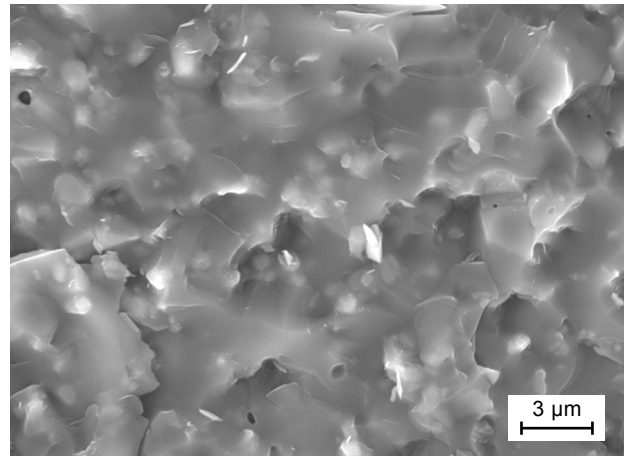

Figure 3. XRD diffraction patterns for the glass-only MGG-30 and selected DOE samples containing ceramic fillers after sintering at 900°C.



a) MGG-30



b) SPL No. 1

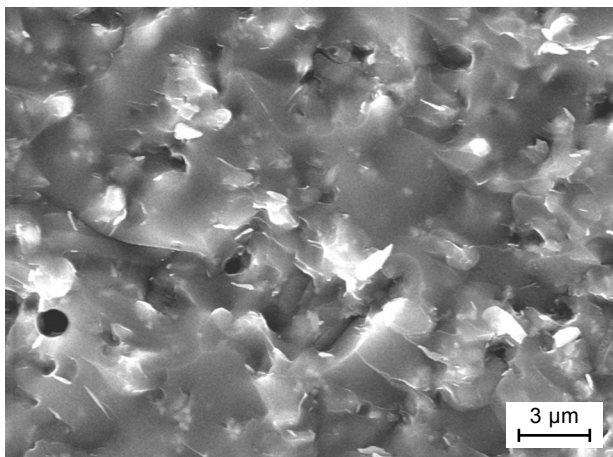

c) SPL No. 3

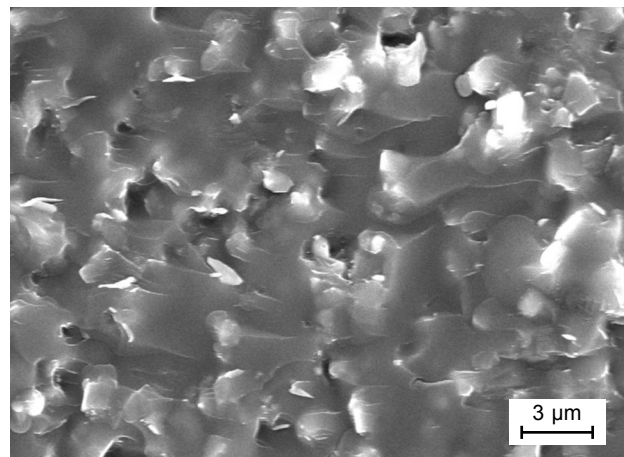

d) SPL No. 6

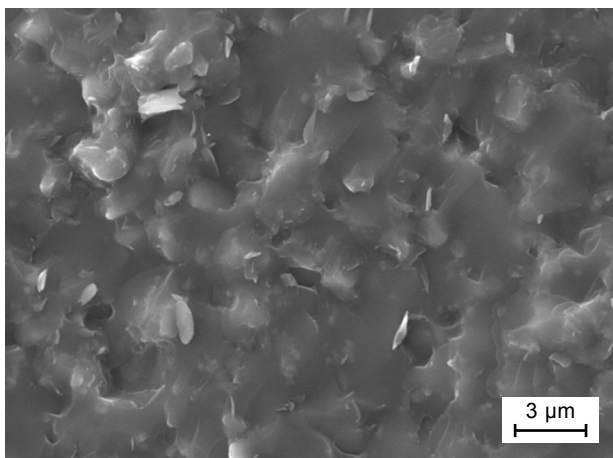

e) SPL No. 8

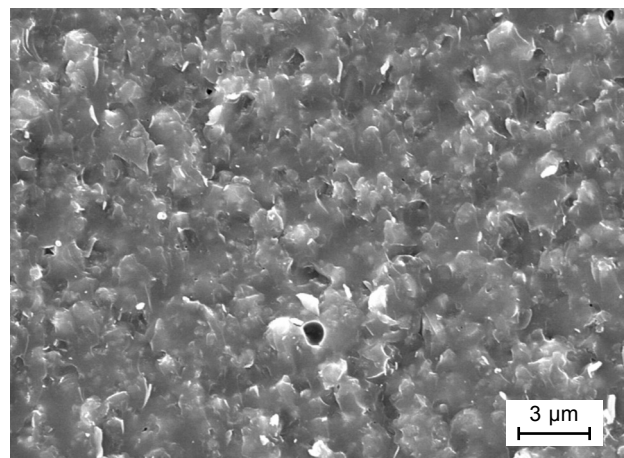

f) SPL No. 9

Figure 4. FESEM morphologies of the fractured surface for glass-only MGG-30 (a) and the selected DOE samples (b - f) after sintering at 900°C.

phology of the corresponding samples sintered at the same condition. MGG-30 showed partly vitrified morphology, while the selected DOE samples show fully densified microstructure without any remarkable pores due to the liquid phase sintering. The explanation on the densification process of glass-ceramic composites by conventional three-stage liquid phase sintering can be found elsewhere [8].

The dissolution of Al_2O_3 into the glass system and subsequent formation of crystallization phase via a diffusion process are defined well for the second-type LTCC system [13]. However, poor mechanical properties due to the recrystallization of the constituents should be avoided. Regarding the effects of filler size for the first-type system, Seo et al. [7] reported that the Al_2O_3 filler size of 0.5-3.0 μm was acceptable in producing the desirable physical and dielectric properties for LTCC application compared to nano-sized filler retarding the sintering, which justifies the selection of 1.86 μm -sized Al_2O_3 powder in this study.

As explained in the previous section, the dielectric constant of our system needs to be increased to around 8.0 from 6.25 of MGG-30 glass for commercialization. TiO_2 was chosen due to its relatively high dielectric constant ($\epsilon_r = 85$) for this purpose because the increase in the dielectric constant of the composite could be expected based on the mixture rule for this first-type LTCC system. Moreover, it was previously demonstrated that TiO_2 with borosilicate was a non-reactive system [8]. CuO was added to enhance sintering since CuO is known to form eutectic composition with TiO_2 at 919°C without any intermediate compound formation. Even though there has been controversy about the effects TiO_2 phase (rutile or anatase) on the sintering and dielectric properties [5,8,14], rutile phase was chosen for this study according to Shin et al.'s reports [14].

Table 2 presents the physical properties of the 900°C-sintered MGG-30 and DOE samples, including sintered density, dielectric constant and mechanical strength. The percentage sintered density with respect to the theoretical one is also shown due to the variation of

ceramic filler amounts with different specific gravity. All samples showed exceptionally high sintered density compared to the previous reports using different LTCC systems [5,8,14]. The DOE composites showed higher density along with larger dielectric constant and flexural strength than glass-only MGG-30. Therefore, it was found that the significant advantages on physical and dielectric properties could be obtained by a proper compositional selection.

In order to explain the behavior of these output responses with the input factors of ceramic fillers in terms of DOE, the main effects plots are presented in Figure 5 for (a) sintered density, (b) dielectric constant and (c) flexural strength. A dashed reference line is drawn at the grand mean of the corresponding data, and circle symbols in the graph are the means of the corresponding output response at two levels of each input factor. The diamond symbols represent the center points which correspond to the output response of mid-level of each input factor. The position of the diamond symbol on or near the lines connecting the effect averages would indicate a little curvature in the experiment, whereas that far from the lines would indicate some measure of curvature in the system. Among the 3 input factors, CuO showed the steepest slope between the two levels, indicating it to be the most significant factor for the sintered density, as shown in Figure 5a. TiO_2 and CuO were the significant factors for the dielectric constant, both of which showed an increasing value with increasing content, as shown in Figure 5b. This was due to their higher dielectric constant 85 and 18, respectively, compared to those of MGG-30 ($\epsilon_r = 6.25$) and Al_2O_3 ($\epsilon_r = 9.70$). Regarding the flexural strength shown in Figure 5c, the effects of TiO_2 and B_2O_3 were greater than that of CuO , whereby the mechanical strength increased with increasing content of both ceramic fillers. The center points for sintered density and dielectric constant were located near the lines connecting the effect average, indicating little curvature for these output responses, while the flexural strength showed a relatively larger amount of curvature.

Table 2. Physical properties of the glass-only MGG-30 and DOE samples with ceramic fillers after sintering at 900°C.

Sample No.	Sintered density (g/cm^3)	% sintered density	Dielectric constant	Flexural strength (MPa)
MGG-30	2.36 ± 0.02	98.33	6.25 ± 0.13	170.00 ± 10.25
1	2.85 ± 0.02	99.51	7.47 ± 0.15	181.09 ± 19.18
2	2.92 ± 0.02	99.70	7.66 ± 0.13	177.35 ± 7.80
3	2.85 ± 0.01	98.35	7.81 ± 0.08	174.41 ± 8.38
4	2.94 ± 0.01	99.33	8.18 ± 0.01	219.02 ± 37.25
5	2.85 ± 0.02	99.61	7.40 ± 0.15	199.63 ± 15.67
6	2.91 ± 0.02	99.81	7.55 ± 0.17	189.51 ± 28.33
7	2.86 ± 0.02	98.96	7.90 ± 0.25	239.49 ± 33.74
8	2.92 ± 0.01	99.00	8.37 ± 0.33	258.10 ± 31.81
9	2.89 ± 0.01	99.36	7.85 ± 0.11	216.46 ± 23.64

To explain the behavior of the dielectric constant of the DOE samples using a traditional mixing model, series [15], parallel [15] and Lichtenecker's mixing models [16,17] were applied after considering the dielectric constant of each constituent. The mathematical equations for each model are described as follows:

a) series mixing model [15]: $\frac{1}{K_m} = \frac{V_1}{K_1} + \frac{V_2}{K_2} \dots + \frac{V_n}{K_n}$

b) parallel mixing model [15]:

$$K_m = V_1K_1 + V_2K_2 \dots + V_nK_n$$

c) Lichtenecker's mixing model [16,17]:

$$\ln K_m = V_1 \ln K_1 + V_2 \ln K_2 \dots + V_n \ln K_n$$

where K_m and K_n represent the dielectric constant of the composite and phase n , respectively, and V_n is the volume fraction of phase n . The series and parallel mixing models represent the extreme cases where the model comprises alternating layers of each phase, perpendicular and parallel to the applied field [15]. Lichtenecker's mixing model represents a widely used empirical relationship without any concern for the physical geometry of the composite system [16,17]. Among these three models, Lichtenecker's mixing model showed the most similar behavior compared to the observed dielectric constant with the correlation factor (R^2 -value) of 83.4%, as shown in Figure 6, although the experimental and model values diverged slightly.

Table 3 summarizes the percentage contribution of each input factor, including the 2- and 3-way interactions and the curvature for output responses based on analysis of variance (ANOVA) results. Most of the effects on output responses resulted from the main effects, especially for the sintered density and dielectric constant, with relatively insignificant amounts of other effects such as interactions and curvature. It indicates that our experimental system belongs to the first-type LTCC system with negligible amount of the reactions among constituents.

Based on the physical properties of the DOE samples sintered at 900°C shown in Table 2, most of nine samples showed superior characteristics to the glass-

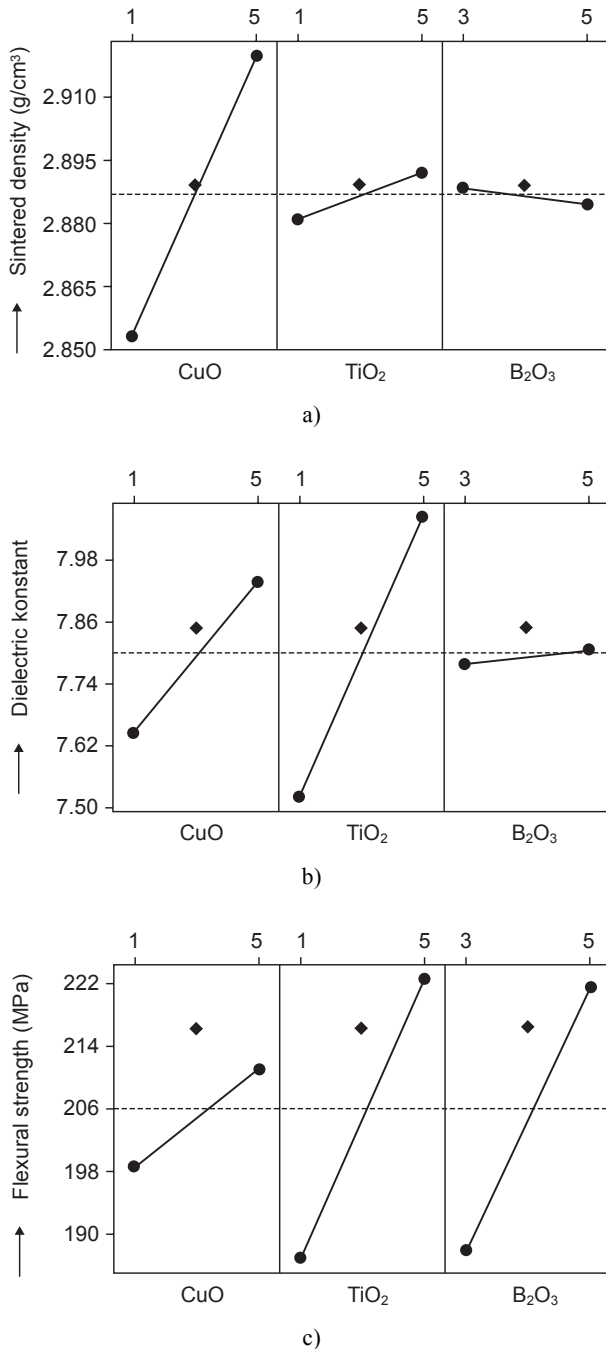

Figure 5. Main effects plot for a) sintered density, b) dielectric constant and c) flexural strength of the DOE samples as a function of input factors after sintering at 900°C for 40 min.

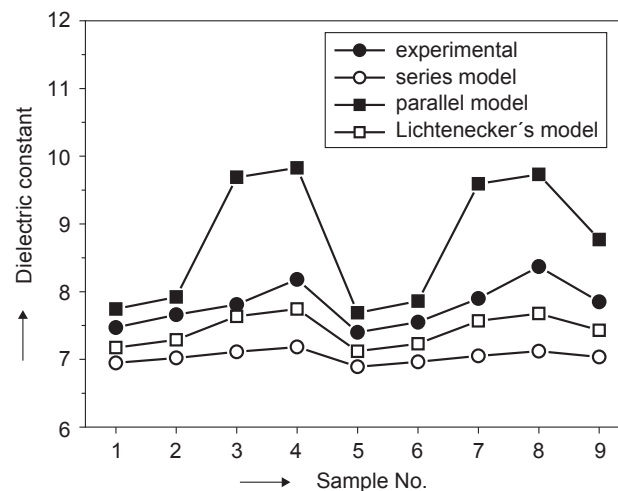

Figure 6. Comparison of the dielectric constant behavior of the DOE samples with series, parallel and Lichtenecker's mixing models.

only MGG-30. Sample No. 8 with 5 wt.% of CuO, TiO₂ and B₂O₃ was chosen as the optimum composition based on the commercial requirements for this system. Although the dielectric constant of this sample was

slightly higher than the commercial requirement of 8.0, this property was tunable by adjusting the amount of ceramic fillers based on the model equation of DOE or the mixing model explained above.

Table 3. Percentage contribution of input factors to the output responses based on analysis of variance (ANOVA).

Output response	Main effects	2-way interactions	3-way interactions	Curvature
Sintered density	97.53% (CuO: 94.60%) (TiO ₂ : 2.61%) (B ₂ O ₃ : 0.32%)	1.40%	1.00%	0.07%
Dielectric constant	92.37% (CuO: 21.10%) (TiO ₂ : 71.12%) (B ₂ O ₃ : 0.15%)	6.98%	0.30%	0.35%
Flexural strength	75.00% (CuO: 6.04%) (TiO ₂ : 36.80%) (B ₂ O ₃ : 32.16%)	22.55%	0.70%	1.75%

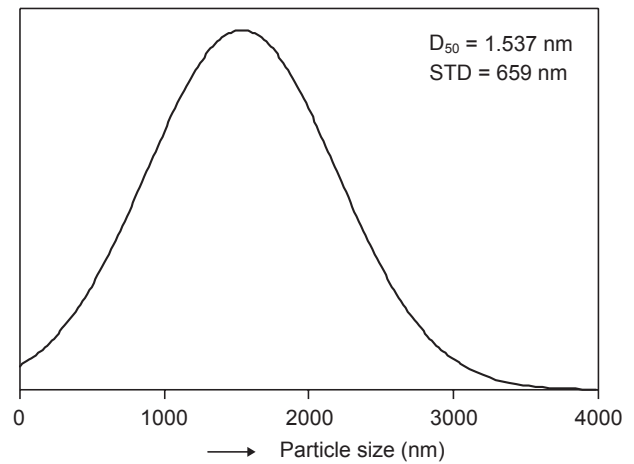
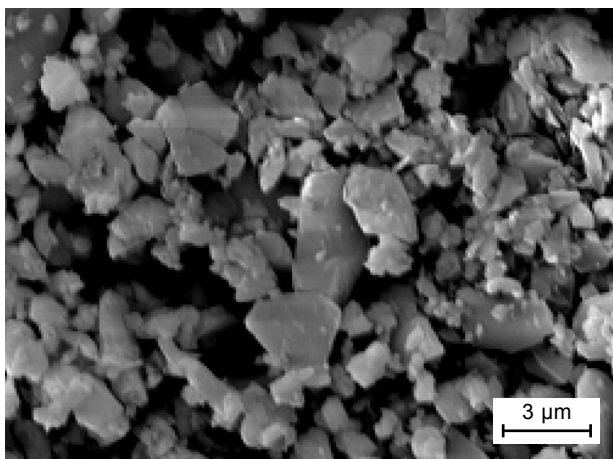

a) Ball-milled

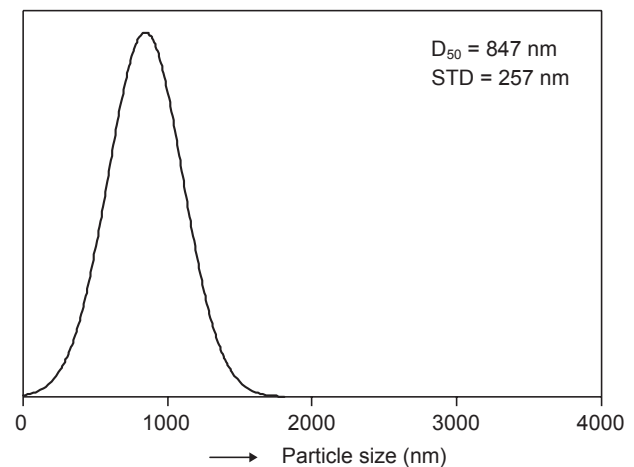
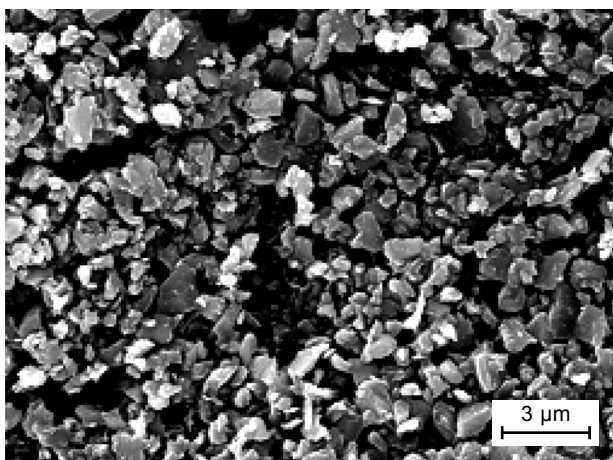

b) High energy-milled

Figure 7. Comparison of starting materials for a) 24 hours of ball-milled and b) 2 hours of high energy-milled sample No. 8 with corresponding particle size distributions.

Two hours of high energy milling was performed for the chosen optimum condition to check the effect of particle size on sintered properties, and the resultant particle size is compared to the powder exposed to 24 hours of ball milling in Figure 7. Two hours of high energy milling generated much finer particle size with sharper size distribution than those of ball milled powder as shown with the particle size distribution in Figure 7. Modern high energy mills utilizing a high speed rotor and very fine grinding media is known to achieve a very small particle size down to the nanome-

ter range in a very short processing time [18]. It was expected that the fine starting materials by heavy milling decrease the reaction temperature due to their high activity and shorter diffusion length. As shown in Table 4, the similar mechanical and dielectric properties of 900°C sintered sample with ball-milled powder could be achieved even at 860°C with high energy-milled one. However, the overall properties were deteriorated at the sintering temperature of 920°C, which was due to the pore coarsening associated with the excessive sintering, as shown in Figure 8.

Table 4. Comparison of physical properties between high energy-milled composites sintered at various temperatures and the DOE sample No. 8 sintered at 900°C.

Milling method	Sintering temperature (°C)	Sintered density (g/cm ³)	Dielectric constant	Flexural strength (MPa)
High energy milling	860	2.91	8.27	226.47
	880	2.92	8.45	254.34
	900	2.92	8.42	248.78
	920	2.75	7.86	178.20
Ball milling	900	2.92	8.37	258.10

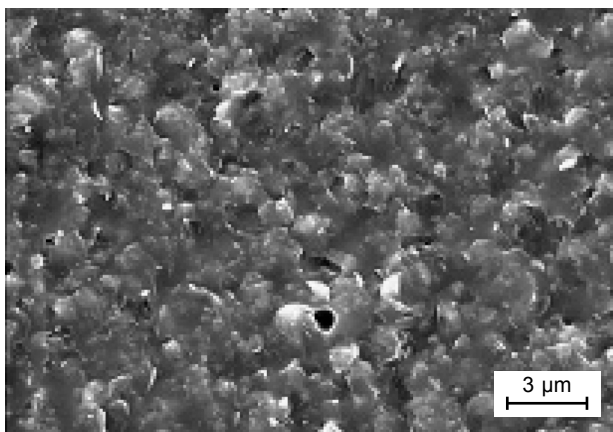

a) 860°C

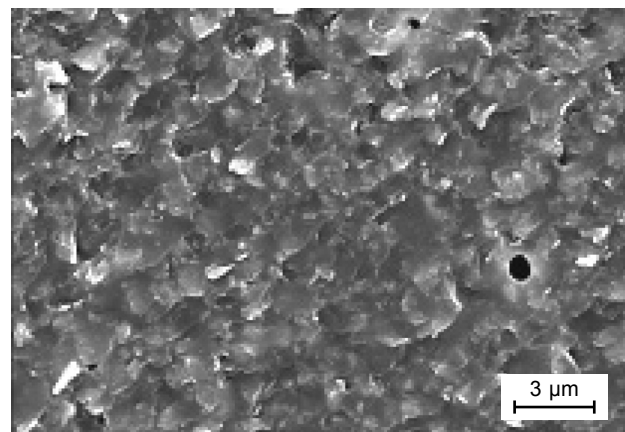

b) 880°C

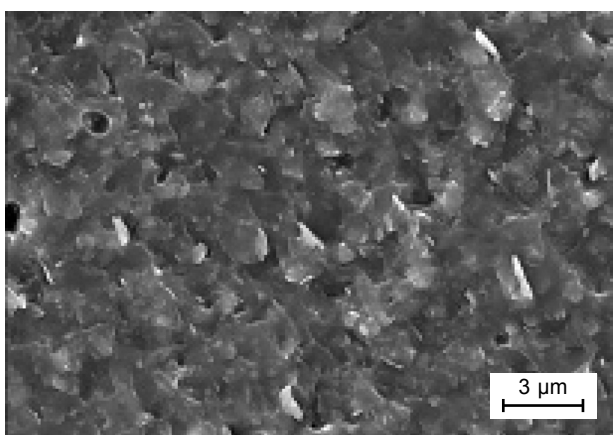

c) 900°C

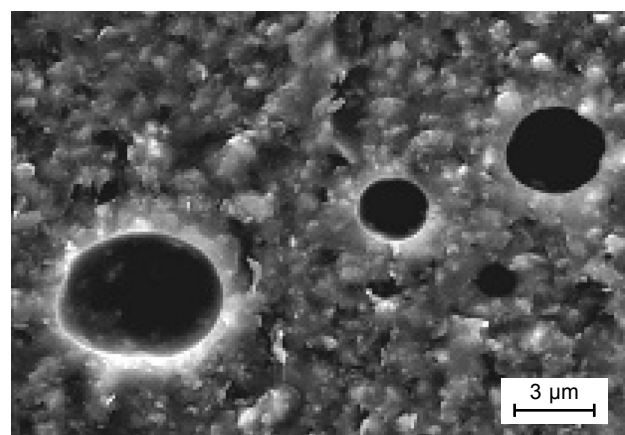

d) 920°C

Figure 8. FESEM morphologies of the fractured surface for the chosen optimum composition after 2 hours of high energy milling after sintering at a) 860, b) 880, c) 900°C and d) 920°C.

CONCLUSION

The effects of CuO, TiO₂ and B₂O₃ addition as ceramic fillers to a commercial, alumino-borosilicate glass mixture system with 40 wt.% of Al₂O₃ were investigated. The optimum composition of the above ceramic fillers was determined, by using full-factorial DOE technique, to be effective in decreasing the sintering temperature and improving the dielectric and mechanical properties for LTCC application. Most of the ceramic fillers were maintained in the original phase without any significant intermediate phase formation, indicating the first type LTCC system. Most of the effects exerted on the output responses resulted from the main effects, with relatively insignificant amounts of other effects such as interactions and curvature, according to the statistical analysis. To explain the effect of each phase on the dielectric constant of the DOE samples, the experimental results were compared with 3 kinds of dielectric mixing models, from which Lichtenecker's mixing model was shown to be applicable for this case. Among the 9 DOE samples, that with 5 wt.% of CuO, TiO₂, and B₂O₃ added, which was sintered at 900°C for 40 min in air after 24 hours of ball milling, showed an optimum properties with the dielectric constant of 8.3, relative density of 99%, and flexural strength of 258 MPa. In addition, it was found that the decrease in the adequate sintering temperature from 900°C to 860°C was possible by decreasing the average particle size of starting materials from 1.54 μm down to 0.85 μm using a high energy mill, without any significant deterioration of overall properties.

Acknowledgement

This research was supported by the Yeungnam University research grants in 2007.

References

1. Tummala R. R.: J.Am.Ceram.Soc. 74, 895 (1991).
2. Kim M. H., Jeong Y. H., Nahm S., Kim H. T., Lee H. J.: J.Eur.Ceram.Soc. 26, 2139 (2006).
3. Jung B. H., Hwang S. J., Kim H. S.: J.Eur.Ceram.Soc. 25, 3187 (2005).
4. Dai S. X., Huang R. F., Wilcox Sr. D. L.: J.Am.Ceram.Soc. 85, 828 (2002).
5. Yoon S. H., Kim D. W., Cho S. Y., Hong K. S.: J.Eur.Ceram. Soc. 23, 2549 (2003).

6. Jean J. H., Chang C. R., Chang R. L., Kuan T. H.: Mater. Chem.Phys. 40, 50 (1995).
7. Seo Y. J., Jung J. H., Cho Y. S., Kim J. C., Kang N. K.: J.Am.Ceram.Soc. 90, 649 (2007).
8. Jean J. H., Lin S. C.: J.Mater.Res. 14, 1359 (1999).
9. Lu F. H., Fang F. X., Chen Y. S.: J.Eur.Ceram.Soc. 21, 1093 (2001).
10. Montgomery D. C.: *Design and Analysis of Experiments*, 3rd ed., p.197-249, John Wiley & Sons, New York 1991.
11. Kako T., Iri H., Hashimoto K.: J.Photochem.Photobiol. A 171, 131 (2005).
12. Web-site of "CB Mills Division of Chicago Boiler Company," <http://www.cbmills.com>.
13. Wilcox Sr. D. L., Huang R. F., Dai S. X.: Ceramic Transaction 97, 201 1998.
14. Shin C. K., Paek Y. K., Lee H. J.: Int.J.Appl.Ceram.Tech-nol. 3, 463 (2006).
15. Borrow D., Petroff T., Tandon R., Sayer M.: J.Appl.Phys. 81, 876 (1997).
16. Goodman G. in: *Ceramic Materials for Electronics*, 2nd ed., p.69-128, Ed. Buchanan R.C., Marcel Dekker, New York 1991.
17. Montgomery C. G.: *Techniques of Microwave Measurement*, p.748-751, McGraw-Hill, New York 1947.
18. Ryu S. S., Lee S. K., Yoon D. H.: J.Electroceram. 18, 243 (2007).

MODIFIKACE SYSTÉMU ALUMINO-BORITO-KŘEMIČITÉHO SKLA POMOCÍ KERAMICKÝCH ADITIV PRO POUŽITÍ LTCC

JONG-HYUN KIM, SUNG-WOOK KWON,
HYUN-TAE KIM, DANG-HYOK YOON

*School of Materials Science and Engineering,
Yeungnam University*

Vlivy aditiv CuO, TiO₂ a B₂O₃ na dielektrické a mechanické vlastnosti systému směsi komerčního, bezolovnatého alumino-borito-křemičitého skla a 40 hmot.% Al₂O₃ byly prověřovány pomocí techniky úplného plánování pokusů (DOE) pro nízkoteplotní spoluspálované (LTCC) aplikace. Slinutá hustota, dielektrická konstanta a pevnost v ohybu byly analyzovány statisticky, jako výstupní odezvy pro devět skupin vzorků podle tabulky DOE, po slinování při teplotě 900°C po dobu 40 minut na vzduchu. Optimální složení pro tento systém bylo nalezeno přidáním 5 hmot.% CuO, TiO₂ a B₂O₃, přičemž toto složení vykazovalo dielektrickou konstantu 8,3, relativní hustotu 99 % a pevnost v ohybu 258 MPa. Tyto hodnoty znamenaly značné zlepšení ve srovnání s hodnotami systému skla. V důsledku zanedbatelného vytváření druhé fáze a interakce mezi vstupními faktory souvisejícími s tímto pokusem bylo potvrzeno, že Lichteneckerův směšovací model představoval přesně chování dielektrické konstanty.